

## Planar VM Series



**VM55MX-M2**  
**VM55MX-X2**  
**VM55LX-M2**  
**VM55LX-X2**  
**VM55LX-U2**

Copyright © October 2023 by Planar Systems, Inc.  
All rights reserved.

This document may not be copied in any form without permission from Planar. Information in this document is subject to change without notice.

#### Trademark Credits

Windows™ is a trademark of Microsoft Corp.

The terms HDMI, HDMI High-Definition Multimedia Interface, HDMI Trade dress and the HDMI Logos are trademarks or registered trademarks of HDMI Licensing Administrator, Inc.

All other companies are trademarks or registered trademarks of their respective companies.

#### Disclaimer

The information contained in this document is subject to change without notice. Planar Systems, Inc. makes no warranty of any kind with regard to this material. While every precaution has been taken in the preparation of this manual, the Company shall not be liable for errors or omissions contained herein or for incidental or consequential damages in connection with the furnishing, performance, or use of this material.

#### Warranty and Service Plans

Planar warranty and service plans will help you maximize your investment by providing great support, display uptime, and performance optimization. From post-sale technical support, to a full suite of depot services, our services are performed by trained employees. When you purchase a Planar product, you get more than a display; you get the service and support you need to maximize your investment. To find the latest warranty and service information regarding your Planar product, please visit <http://www.planar.com/support>

#### RoHS Compliance Statement

The Planar VM Series is fully RoHS compliant.

Part Number: 020-1357-03B

# Table of Contents

<b>Introduction</b> .....	5
1. Safety Information .....	6
2. Safety Precautions.....	6
2.1 Important Safety Instructions .....	7
3. Recommended Usage .....	8
3.1 Burn-In Versus Temporary Image Retention .....	8
3.2 Warranty Coverage.....	8
3.3 Important Waste Disposal Information .....	9
3.4 European Product Database for Energy Labeling (EPREL) .....	9
3.5 Normal Usage Guidelines .....	9
3.6 ENERGY STAR Certified.....	10
4. VESA Mounts, General Description.....	11
4.1 Installing the Alignment Brackets.....	11
5. Cleaning the Display .....	14
<b>Package Contents</b> .....	15
6. Installing the Cable Clips .....	18
7. Planar VM Series - Standard Inputs .....	19
<b>Installing the Display</b> .....	20
8. Before You Begin .....	20
8.1 Tools/Equipment List .....	20
8.2 Other Things You May Need .....	20
8.3 Plan Your Installation .....	20
8.4 Prepare Your Installation Location.....	21
8.5 Cable Length Recommendations.....	21
8.6 Unpacking .....	22
8.7 Thermal Expansion .....	23
8.8 Connecting External Equipment .....	24
9. Installing OPS Expansion (Optional) .....	26
10. Installing Cosmetic Trim (Optional) .....	27
<b>Operating the Display</b> .....	28
11. OSD Keypad.....	28
12. LED Indicators.....	29
13. Using the Display in Flat or Tilted Orientation.....	30

14.	Using the Remote Control.....	31
15.	Pairing the Remote Control to the Display.....	32
16.	Basic Remote Functions.....	33
16.1	Turning the Display On .....	33
16.2	Turning the Display Off .....	33
16.3	Adjusting the Volume .....	33
16.4	Selecting the Input Source.....	33
16.5	Navigating Through the Menus.....	33
17.	OSD Main Menu.....	34
17.1	Picture.....	34
17.2	Screen .....	38
17.3	Audio.....	40
17.4	Configuration 1 .....	42
17.5	Configuration 2 .....	45
17.6	Advanced Option .....	48
18.	Tiling Configuration.....	55
18.1	Layout.....	55
18.2	Color Balance .....	56
18.3	Frame Compensation .....	58
	<b>External Control.....</b>	<b>60</b>
	<b>Signal Compatibility.....</b>	<b>61</b>
	<b>Color Subsampling Support.....</b>	<b>63</b>
	<b>Power Consumption.....</b>	<b>64</b>
	<b>Specifications.....</b>	<b>65</b>
	<b>Dimensions.....</b>	<b>68</b>
	<b>Troubleshooting.....</b>	<b>69</b>
	<b>Accessing the Planar Technical Support Website .....</b>	<b>71</b>
	<b>Index .....</b>	<b>72</b>

# Introduction

The second-generation Planar® VM Series is an ultra-narrow bezel LCD display that provides a video wall solution for the demanding requirements of 24x7 mission-critical applications. By incorporating IPS panel technology, the result is outstanding viewing angles and contrast.

The Planar VM Series features 55" Full HD LCD displays with tiled bezel widths of 0.88, 2.6 or 3.5mm and 700 or 500-nit brightness. The Planar VM Series delivers high reliability to meet the demands of digital signage applications including retail, hospitality, universities, sports bars, corporate lobbies, casinos and museums.

Designed for commercial installations, Planar VM Series comes standard with a full array of inputs and connectivity for external control systems, including support for native 4K resolution at up to 60Hz, video loop through via DisplayPort 1.2, with built in processing for video walls up to 100 (10x10) panels. Compatible with new and emerging 4K sources, the Planar VM Series uses HDCP 2.2-compliant HDMI® 2.0 inputs. An embedded OPS (Open Pluggable Specification) slot enables seamless integration of compatible digital signage hardware, integrated directly within the video wall.

**Caution:** This manual is intended for use by qualified service persons and end users with experience installing LCD displays.

# 1. Safety Information

Before using the Planar VM Series, please read this manual thoroughly to help protect against damage to property, and to ensure personnel safety.

- Be sure to observe the following instructions.
- For your safety, be sure to observe ALL the warnings detailed in this manual.
- For installation or adjustment, please follow this manual's instructions, and refer all servicing to qualified service personnel.

# 2. Safety Precautions

- **If water is spilled or objects are dropped inside the display, remove the power plug from the outlet immediately.** Failure to do so may result in fire or electrical shock. Contact your dealer for inspection.
- **If the display is dropped or the chassis is damaged, remove the power plug from the outlet immediately.** Failure to do so may result in fire or electrical shock. Contact your dealer for inspection.

**WARNING!** Wall mounts must be secure.

- **If the display is hung on a wall, the wall must be strong enough to hold it.** Simply mounting it to wallboard or wall paneling won't be adequate or safe.

**Caution:** The screen could be damaged by heavy pressure.

- **Slight pressure on the LCD will cause distortion of the image.** Heavier pressure will cause permanent damage. Displays should be mounted where viewers cannot touch the screen or insert small objects in the openings that will create hazards by contacting bare conductive parts.

**Caution:** The front polarizer is soft and subject to scratches from sharp objects.

- **The polarizer is a thin sheet of film laminated to the outside layer of glass on the LCD screen.** Take care when handling items near the screen.
- **If the power cord or plug is damaged or becomes hot, turn off the main power switch of the display. Make sure the power plug has cooled down and remove the power plug from the outlet.** If the display is still used in this condition, it may cause a fire or an electrical shock. Contact your dealer for a replacement.

## 2.1 Important Safety Instructions

1. Read these instructions.
2. Keep these instructions.
3. Heed all warnings.
4. Follow all instructions.
5. Do not use the display near water.
6. Clean the LCD screens with an LCD screen cleaner or LCD wipes.
7. Do not install near any heat sources such as radiators, heat registers, stoves or other apparatus (including amplifiers) that produce heat.
8. Do not defeat the safety purpose of the polarized or grounding type plug. A polarized plug has two blades with one wider than the other. A grounding type plug has two blades and a third grounding prong. The wide blade or the third prong is provided for your safety. When the provided plug does not fit into your outlet, consult an electrician for the replacement of the obsolete outlet.
9. Protect the power cord from being walked on or pinched, particularly at plugs, convenience receptacles and the point where they exit from any Planar large format LCD display.
10. Only use the attachments/accessories specified by the manufacturer.
11. Unplug all displays during lightning storms or when unused for long periods of time.
12. In instances where a power surge has occurred and a display no longer has an image, the display power will need to be reset.
13. You must follow all National Electrical Code regulations. In addition, be aware of local codes and ordinances when installing your system.
14. Refer all servicing to qualified service personnel. Servicing is required when any of the displays have been damaged in any way, such as the AC power cord or plug is damaged, liquid has been spilled or objects have fallen into a product, the products have been exposed to rain or moisture, do not operate normally or have been dropped.
15. Keep the packing material in case the equipment should ever need to be shipped.
16. Wall mounts must be secure. The wall must be strong enough to hold displays brackets, cables and accessories. Seismic engineers should be consulted in areas prone to earthquakes.
17. Slight pressure on the LCD will cause distortion of the image. Heavier pressure will cause permanent damage. Displays should be mounted where viewers cannot touch the screen or insert small objects in the openings that will create hazards by contacting bare conductive parts.
18. The front polarizer is soft and subject to scratches from sharp objects. The polarizer is a thin sheet of film laminated to the outside layer of glass on the LCD screen. Take care when handling items near the screen.

**Caution:** There is a risk of explosion if the battery is replaced with incorrect type. Dispose of used batteries according to local regulations.

## 3. Recommended Usage

In order to get the most out of your LCD, use the following recommended guidelines to optimize the display.

### 3.1 Burn-In Versus Temporary Image Retention

Burn-in causes the screen to retain an image essentially forever, with little or no way to correct the problem. Under normal use, an LCD will not experience burn-in, as plasma displays do, nor will it retain images in any way.

Normal use of an LCD is defined as displaying continuously changing video patterns or images. However, LCDs can experience *temporary* image retention when recommended usage guidelines are not followed.

#### ***What is Temporary Image Retention?***

Temporary image retention (TIR) can occur when a static image is displayed continuously for extended periods of time (12 hours or longer). An electrical charge differential may build up between the electrodes of the liquid crystal, which causes a negative-color video image (color-inverted and brightness-inverted version of the previous image) to be retained when a new image is displayed. This behavior is true for any LCD device from any LCD manufacturer.

TIR is not covered under warranty. See standard warranty terms and conditions for details. Here are some guidelines to help you avoid TIR:

- Use the LCD to show a screen saver, moving images or still pictures that change regularly. When using high-contrast images, reposition the images frequently.
- Turn off the LCD when it is not in use. To use your source computer's Power Options Properties, set up your computer to turn off the display when not in use.

### 3.2 Warranty Coverage

The following models are warranted for 24 x 7 usage:

- VM55MX-M2
- VM55MX-X2
- VM55LX-M2
- VM55LX-X2
- VM55LX-U2

Planar recommends turning off the power for **4 hours per day** for optimal performance.

For complete warranty details, please visit [www.planar.com/warranty](http://www.planar.com/warranty).



### 3.3 Important Waste Disposal Information

Please recycle or dispose of all electronic waste in accordance with local, state, and federal laws. Additional resources can be found online at <http://www.planar.com/about/green/>.

The crossed-out wheellie bin symbol is to notify consumers in areas subject to Waste Electrical and Electronic Equipment (WEEE) Directive 2012/19/EU that the product was placed on the market after August 13, 2005 and must not be disposed of with other waste. Separate collection and recycling of electronic waste at the time of disposal ensures that it is recycled in a manner that minimizes impacts to human health and the environment. For more information about the proper disposal of electronic waste, please contact your local authority, your household waste disposal service, or the seller from whom you purchased the product.



### 3.4 European Product Database for Energy Labeling (EPREL)

Registration numbers:

- VM55MX-M2: 958613
- VM55MX-X2: 958611
- VM55LX-M2: 958612
- VM55LX-X2: 958610
- VM55LX-U2: 493625

### 3.5 Normal Usage Guidelines

Normal use of the LCD is defined as operating in the open air to prevent heat buildup, and without direct or indirect heat sources such as lighting fixtures, heating ducts, or direct sunlight that can cause the modules to experience high operating temperatures. For all modules, do not block fans or ventilation openings. If the LCD module will be installed in a recessed area with an LCD surround or enclosure, ensure adequate openings are applied for proper air flow and ventilation.

At 3000 meters or below, the maximum ambient operating temperature for the LCD module cannot be above 40° C nor below the minimum ambient operating temperature of 0° C. If one of these conditions exists, it is up to the installer to ensure that module placement is changed, thermal shielding is provided and/or additional ventilation is provided to keep the display within its nominal operating parameters.

#### ***Cooling Requirements***

For optimal performance, active cooling by the installer should be planned for when the ambient temperature at the top of the wall is predicted to be above the specified ambient temperature for the panel. Cooling may be done behind the displays and depending on the wall configuration.

### 3.6 ENERGY STAR Certified



ENERGY STAR is a program run by the U.S. Environmental Protection Agency (EPA) and U.S. Department of Energy (DOE) that promotes energy efficiency.

The following products qualify for ENERGY STAR in the factory default settings:

- VM55MX-M2
- VM55MX-X2
- VM55LX-X2
- VM55LX-U2

The factory default settings are those in which power savings will be achieved. Changing the factory default picture settings or enabling other features will increase power consumption that could exceed the limits necessary to qualify for ENERGY STAR rating.

For more information on the ENERGY STAR program, refer to [energystar.gov](http://energystar.gov).

## 4. VESA Mounts, General Description

VESA mounts are used to secure the Planar VM Series display. The display can be installed using a variety of VESA mounts available through Planar. If you do not have a VESA mount, and would like to purchase one, contact Planar.

If you purchased a VESA mount, you should have received a separate box with mounting supplies and an installation manual. Follow these instructions carefully.

Keep in mind the following general installation guidelines:

- Screw length is crucial and will vary depending on the type of mount you use. Total screw length includes the penetration length, plus the length required, by the type of VESA mount in use.

**Caution:** Shorter screws will result in insufficient mounting strength and longer screws could puncture parts inside the display. The device may fall, causing serious personal injury or death. To prevent injury, this device must be securely attached to the wall in accordance with the installation instructions supplied with the mount. The mount must be secured to the VM Series display using the four M6x1.0 VESA mounting locations, and 5mm - 10mm thread engagement is required for secure mounting. Select the correct screw/spacer combination for the mount.

- Prior to installation, make sure you know where all of the mounting points are located.
- Follow all safety precautions outlined in the VESA Installation manual.
- Verify the parts received with the list shown in the VESA Installation manual.

### 4.1 Installing the Alignment Brackets

1. Install the alignment bracket hardware on the panel as shown below, depending on the panel position within the wall.

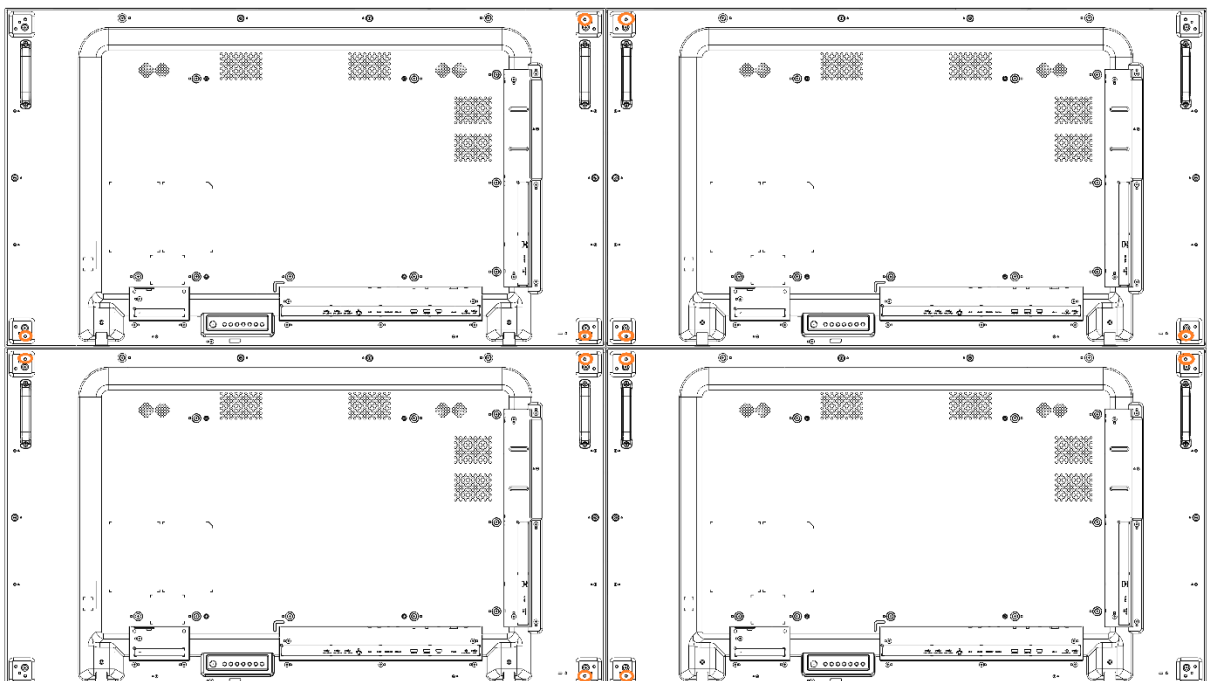

## Alignment Bracket Hardware Installation:

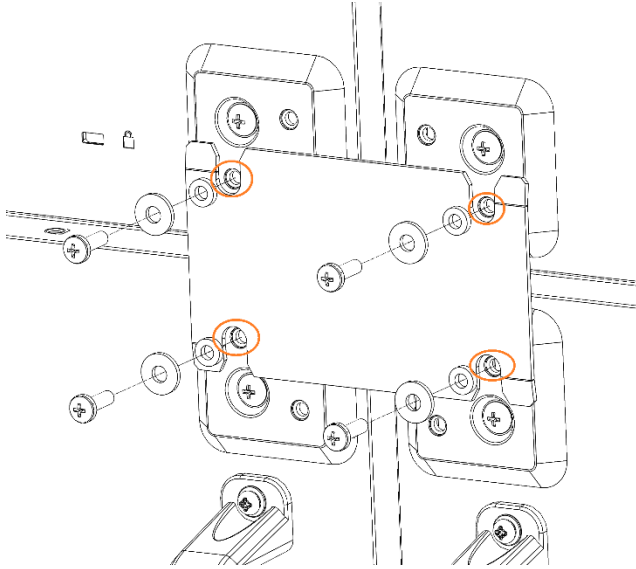

2. Install the brackets as shown after the first row of panels have been installed.

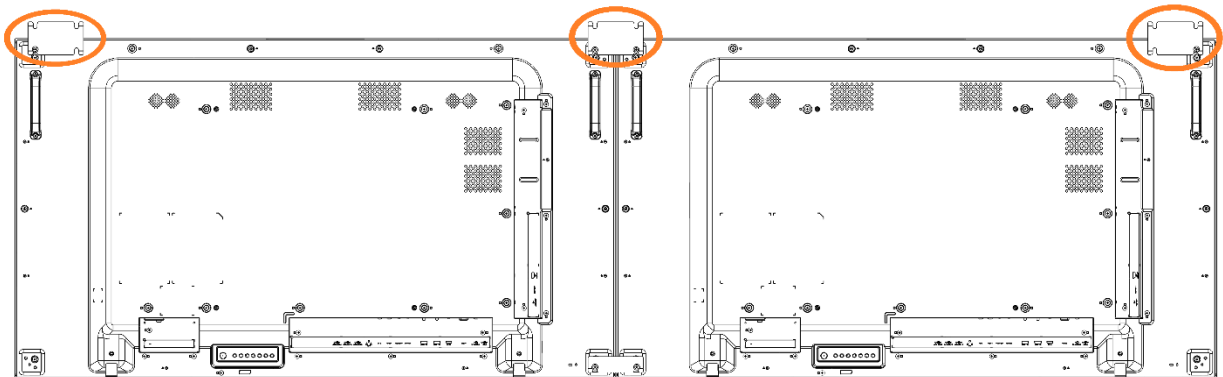

3. Repeat step 2 for subsequent rows of panels.

4. Install the brackets as shown for the bottom of the first row and the top of the last row. Half brackets are required on the top and bottom edges.

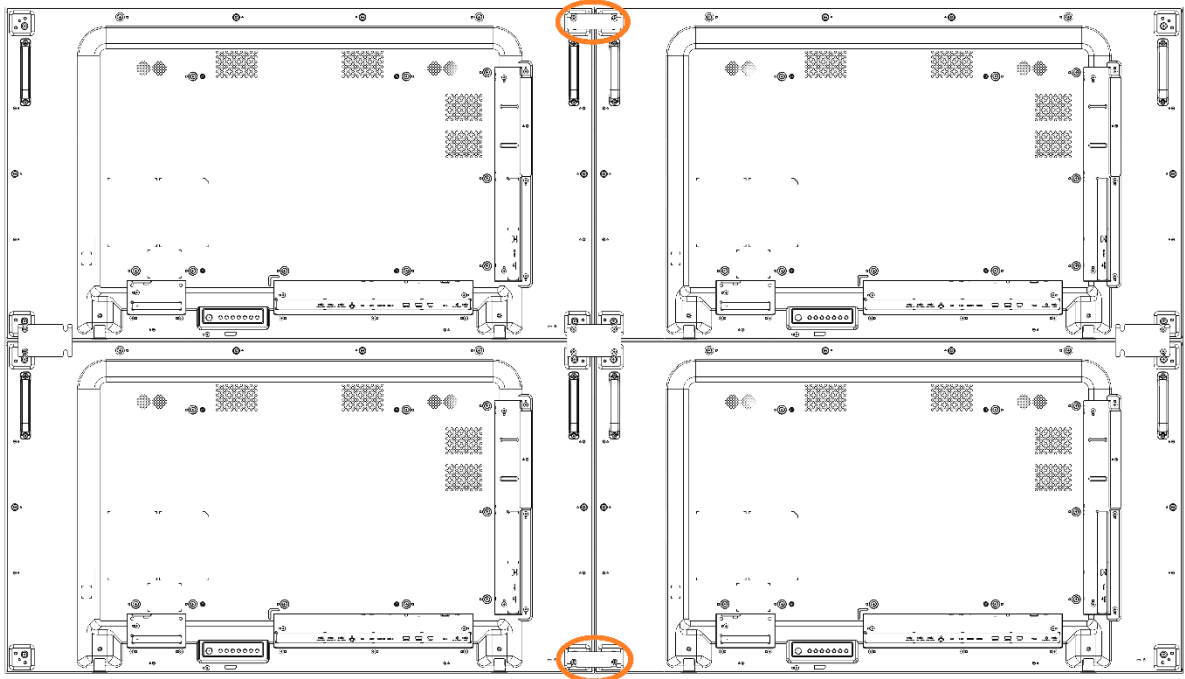

## 5. Cleaning the Display





If dust collects on the power plug, remove the plug from the outlet and clean off the dust. Dust build-up may cause a fire.





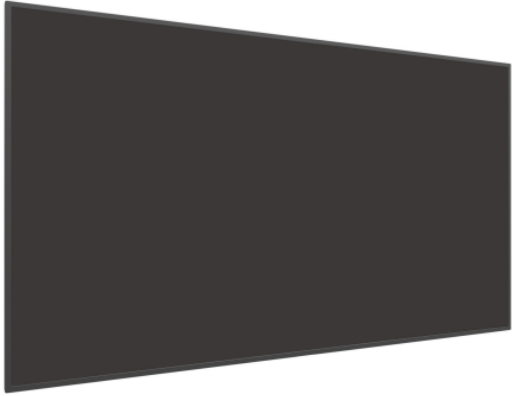

Remove the power plug before cleaning. Failure to do so may result in electrical shock or damage.

Keep the following points in mind when cleaning the surface of the display:



- When the surface of the display becomes dirty, wipe the surface lightly with a soft clean cloth.
- If the surface requires additional cleaning, use LCD screen cleaner or LCD wipes, which are available at most electronics stores.
- Do not let cleaner seep into the display, as it may cause electrical shock or damage.
- Refer to the Planar Display Cleaning Guidelines for more information.

# Package Contents

Part	Description	Number	Picture
LCD Display	One per box.	1	
DP Cable	DP cable.	1	
AC Power Cord	North American power cord.	1	
AC Power Cord	EU power cord.	1	
IR Extender Cable	Used to receive signals from the remote control.	1	

IR Loop Cable	3.5mm (TRS, Male) to 3.5mm (TRS, Male). Used to loop IR communication between the displays. Approximately 1.8 meters.	1	
RS232 Cable	DB9 (Female) to 2.5mm (TRRS, Male) RS232 cable. Receives serial data from a control system. Approximately 1.8 meters.	1	
RS232 Loop Cable	2.5mm (TRRS, Male) to 2.5mm (TRRS, Male). Used to loop RS232 communications between the displays. Approximately 1.8 meters.	1	
Alignment Brackets	Aligns the panels on the wall.	2	
Half Alignment Brackets	Aligns the panels on the wall. Required on the top and bottom wall edges.	1	
M4 Screws, Spacers and Washers	Used for attaching the alignment brackets.	4	

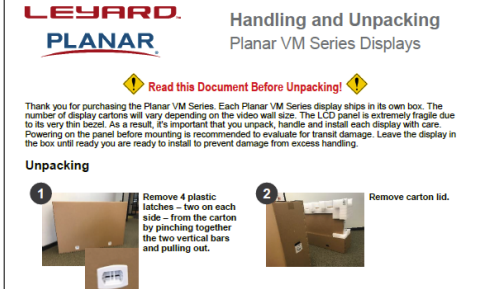

<p>Remote Control</p>	<p>Used to control the display (AAA batteries included).</p>	<p>1</p>	
<p>Cable Clips</p>	<p>Used to clamp and organize the cables.</p>	<p>2</p>	
<p>Quick Start Guide</p>	<p>Quick start guide.</p>	<p>1</p>	
<p>Handling Guide</p>	<p>Handling guide.</p>	<p>1</p>	

## 6. Installing the Cable Clips

Use the cable clips included in the Accessory Kit to assist with cable management. These clips adhere into place using adhesive backing as shown in the image below.

Attach clips near HDMI and AC power cables to assist with cable routing and to release cable strain.

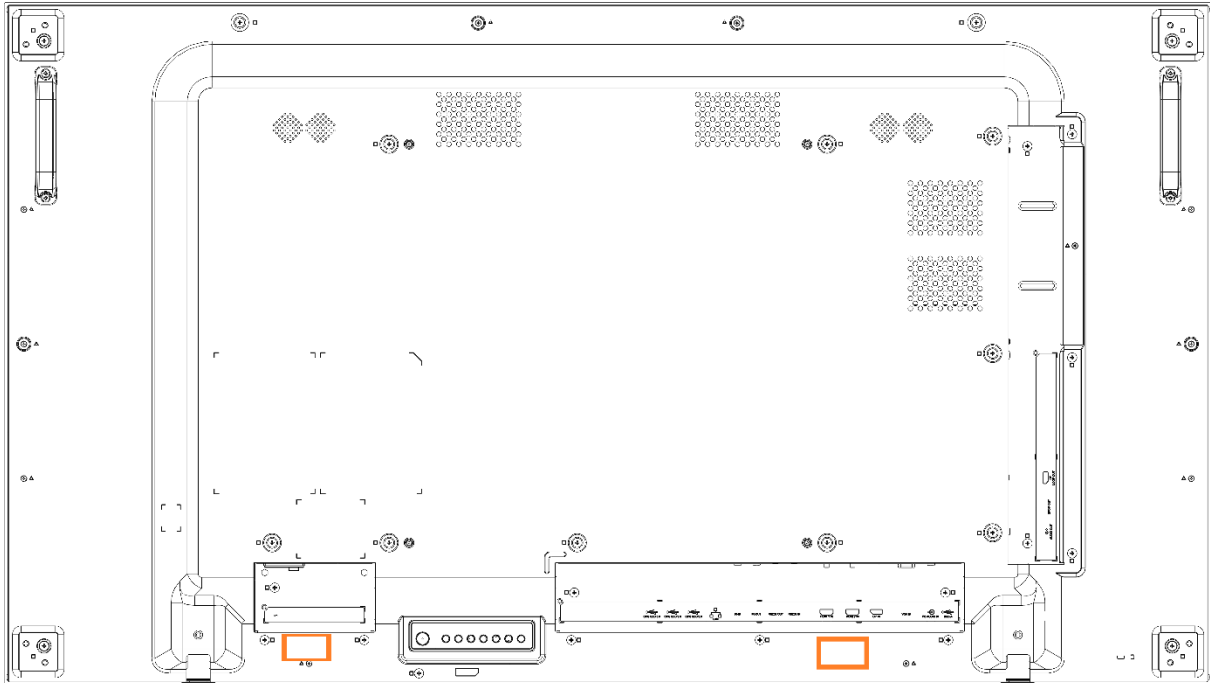

## 7. Planar VM Series - Standard Inputs

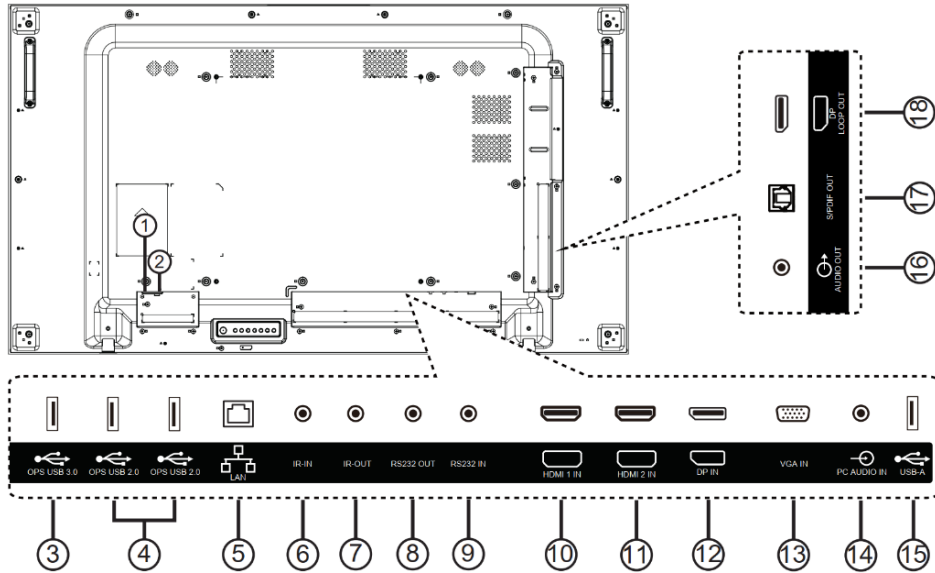

- ① AC IN
- ② MAIN POWER SWITCH
- ③ OPS USB 3.0 / ④ OPS USB 2.0
- ⑤ LAN
- ⑥ IR-IN / ⑦ IR-OUT
- ⑧ RS232 OUT / ⑨ RS232 IN
- ⑩ HDMI 1 IN / ⑪ HDMI 2 IN
- ⑫ DP IN
- ⑬ VGA IN
- ⑭ PC AUDIO IN
- ⑮ USB-A
- ⑯ AUDIO OUT
- ⑰ S/PDIF OUT
- ⑱ DP LOOP OUT

# Installing the Display

This section explains how to install your display. We suggest that you read the entire section before you attempt to install the unit.

## 8. Before You Begin

Make sure you have all the items in these lists before you begin unpacking and installing your display(s).

### 8.1 Tools/Equipment List

Depending on your installation, you may need one or more of the following items:

- String/string level
- Digital/laser level
- Ladders/lift
- Back brace
- Stud finder (if hanging display on a wall)

### 8.2 Other Things You May Need

- LCD screen cleaner or LCD wipes - available at most electronics stores
- At least two very strong people to help lift unit into place

### 8.3 Plan Your Installation

You should have a detailed plan of how the units are to be configured. The plan should include calculations for the following:

- Power maximums reference below by display size
  - VM55MX-M2: 5 units max per 20A circuit for 115VAC operation
  - VM55MX-X2: 5 units max per 20A circuit for 115VAC operation
  - VM55LX-M2: 5 units max per 20A circuit for 115VAC operation
  - VM55LX-X2: 6 units max per 20A circuit for 115VAC operation
  - VM55LX-U2: 7 units max per 20A circuit for 115VAC operation
- Ventilation and cooling requirements
- If hanging display on a wall, location of studs in the wall
- For additional physical spacing requirements, please refer to your video wall mount manual

## 8.4 Prepare Your Installation Location

Prepare the area where you will install the unit. If custom enclosures are part of the installation, they must be fully designed to accommodate the installation of the displays, the installed units, and ventilation and cooling requirements.

If your installation includes a lot of construction or dust, it is **highly recommended** that you clean all of the screens after the wall installation and configuration are complete.

### Please note:

- Panel temperatures can increase 3-5°C with each vertically stacked unit. Accommodate cooling as necessary to meet panel ambient specifications.
- It is recommended that for inset walls 3 tall or less, a minimum of 13mm (0.5") gap be left at the sides and a minimum of 25mm (1.0") gap be left at the bottom.
- Ensure the LCD mounts are mounted flat, level, and plumb.

## 8.5 Cable Length Recommendations

Cable length performance may vary between different cables and sources. The recommended maximum cable lengths are as follows:

### HDMI

- 4K @ 50/60Hz: 8m (25 ft) maximum
- 4K @ 24/25/30Hz: 15m (50 ft) maximum
- 1080p @ 60Hz and lower resolutions: 20m (65 ft) maximum

### DisplayPort

- 8m (25 ft) maximum

## 8.6 Unpacking

Each Planar VM Series display ships in its own box. The number of display cartons will vary depending on the video wall size. The LCD panel is extremely fragile due to its very thin bezel. As a result, it's important that you unpack, handle and install each display with care. Powering on the panel before mounting is recommended to evaluate for transit damage. Leave the display in the box until you are ready to install to prevent damage from excess handling.

1



Remove 4 plastic latches – two on each side – from the carton by pinching together the two vertical bars and pulling out.

2



Remove carton lid.

3



Remove white foam from top of the display.

4

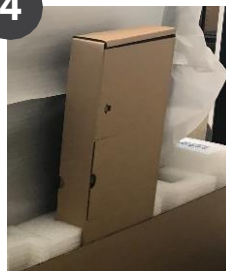

Remove accessories box.

5



Lower plastic bag so handles can be seen.

6



Remove cardboard.

7



Using two people, lift display from box by handles.

8



When installing VESA mount brackets, the panel may be carefully placed on clean, compliant surface (or cardboard/foam removed in step 6) tilted no more than 10°.

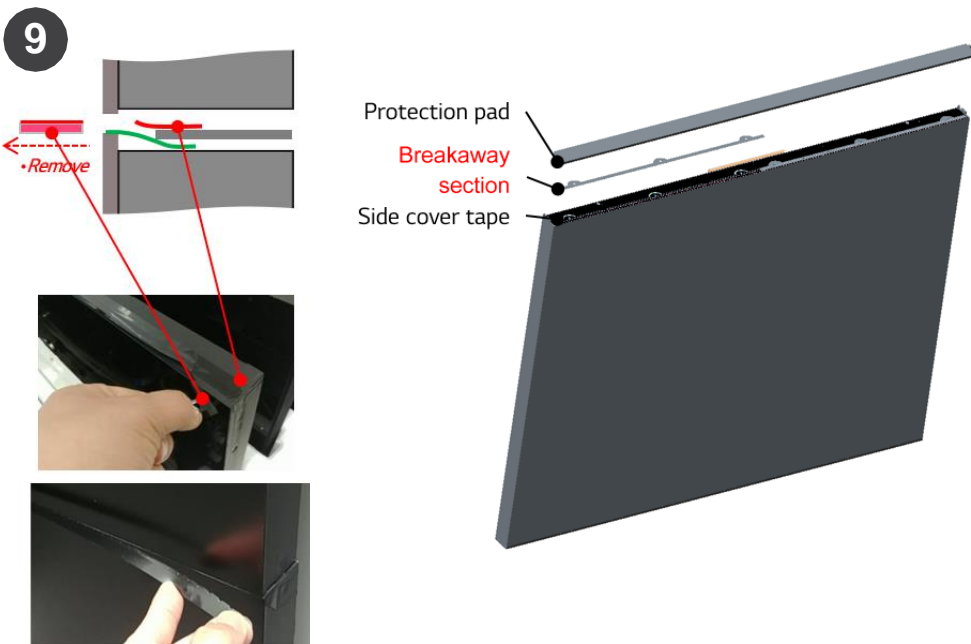

After mounting the panels, remove only the breakaway section of the protective plastic tab from the top of the panel, if present.

**CAUTION:** Do not remove any other portion of the top of the panel, as this may severely damage the display.

### How to SAFELY Handle the VM Series Display



The display should always be vertical. Lift the unit with two (2) people using the handles and the bottom display edge. Take care to not wrap your hands around to the display front – risking panel damage.

### How NOT to Handle the VM Series Display

1. Do NOT lift the display by its bag. The bag tears easily and will not support the weight of the display.
2. Do NOT apply force to the front of the LCD.

**CAUTION:** If the display must be temporarily stored out of its original packaging, do not let it stand at an angle of more than 10°.

## 8.7 Thermal Expansion

Thermal expansion occurs as the LCD displays become warmer during operation. If the distance between the LCD displays is insufficient, the displays may push against each other as they thermally expand and become deformed, a condition referred to as pinching. As a general rule, Planar recommends a gap of at least one business card's thickness (approximately 0.375mm) between panels when installing LCD displays. If pinching is a concern prior to installing or when observing pinching after installation, increase the gap distance to the thickness of at least two business cards (approximately 0.75mm).

## 8.8 Connecting External Equipment

### 8.8.1 Connecting Multiple Displays in a Daisy-chain Configuration

The Planar VM Series displays are designed to be installed in a daisy-chain configuration for video walls. The displays can be connected in the daisy-chain in any order, and any displays can be selected as the first and last displays in the chain.

**Note:** For larger video wall configurations, a distribution amp is recommended.

#### 8.8.1.1 Display Control Connection (refer to RS232 Guide for complete details)

##### RS232

###### Example 1

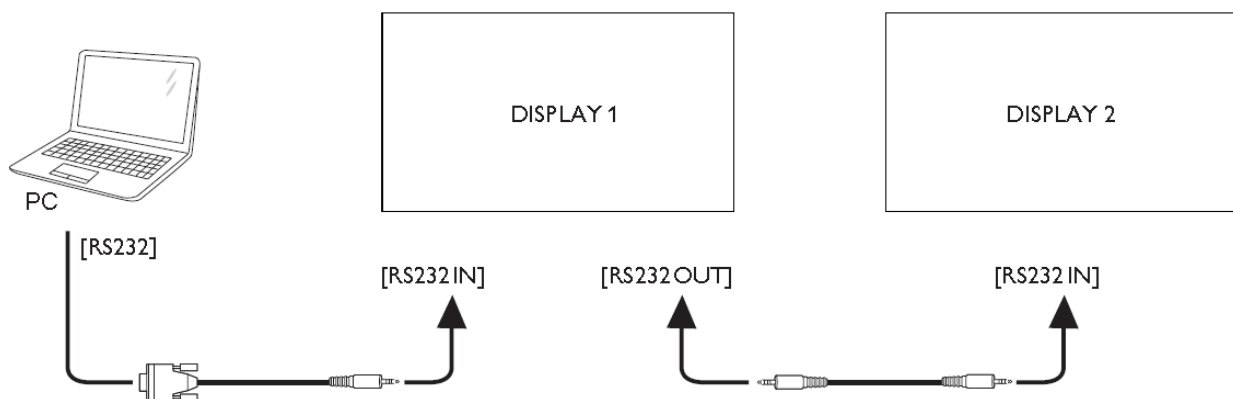

###### Example 2

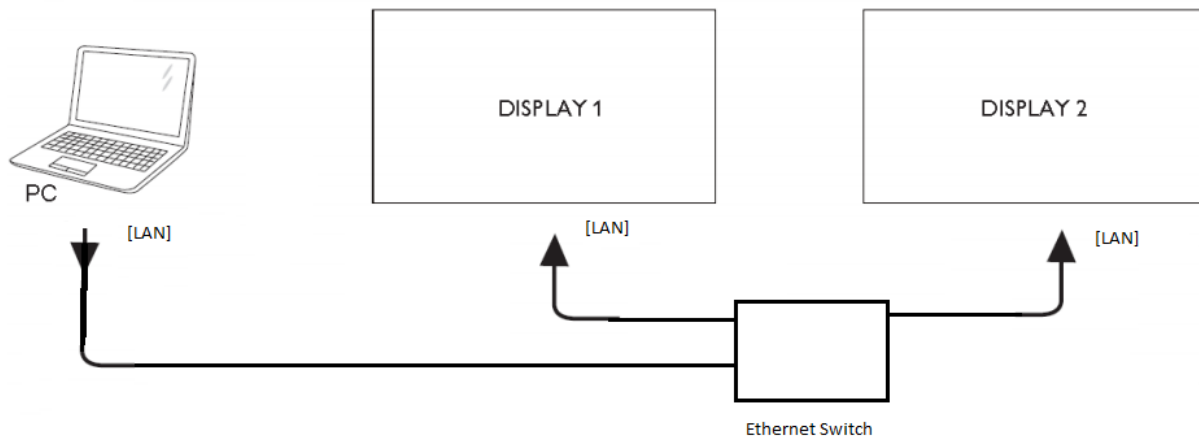



### 8.8.1.2 Digital Video Connection

#### DisplayPort

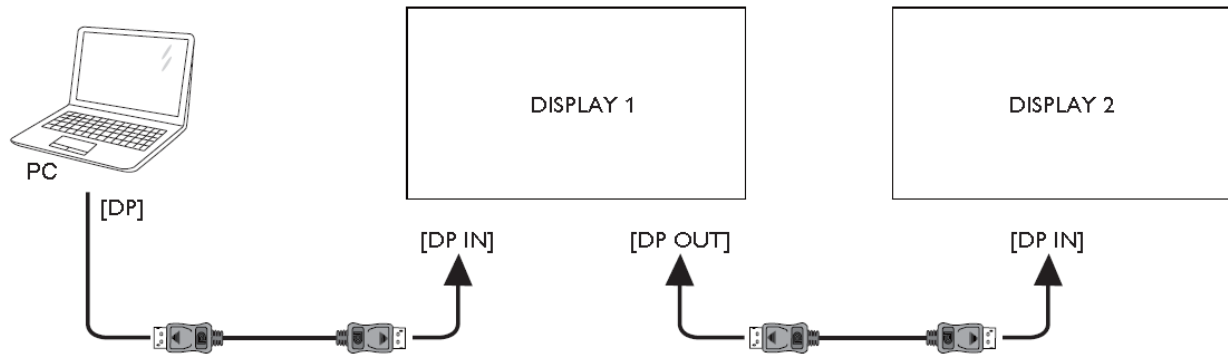

### 8.8.2 IR Connection

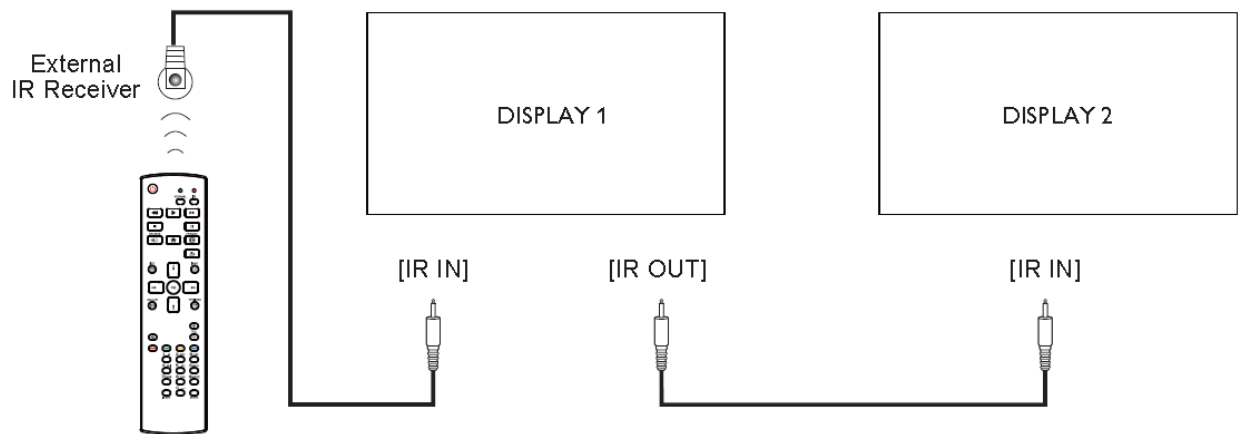

**Note:** This display's remote control sensor will stop working if the [IR IN] is connected.

## 9. Installing OPS Expansion (Optional)

Planar VM Series displays are equipped with an expansion slot that supports the Intel® Open-Pluggable Specification (OPS). The slot supports OPS devices including PCs, SDI modules etc.

To install an OPS device, remove the protective cover on the display and slide the device firmly into position. When installed, the OPS device connects internally to the display. No external video or power cables are required.

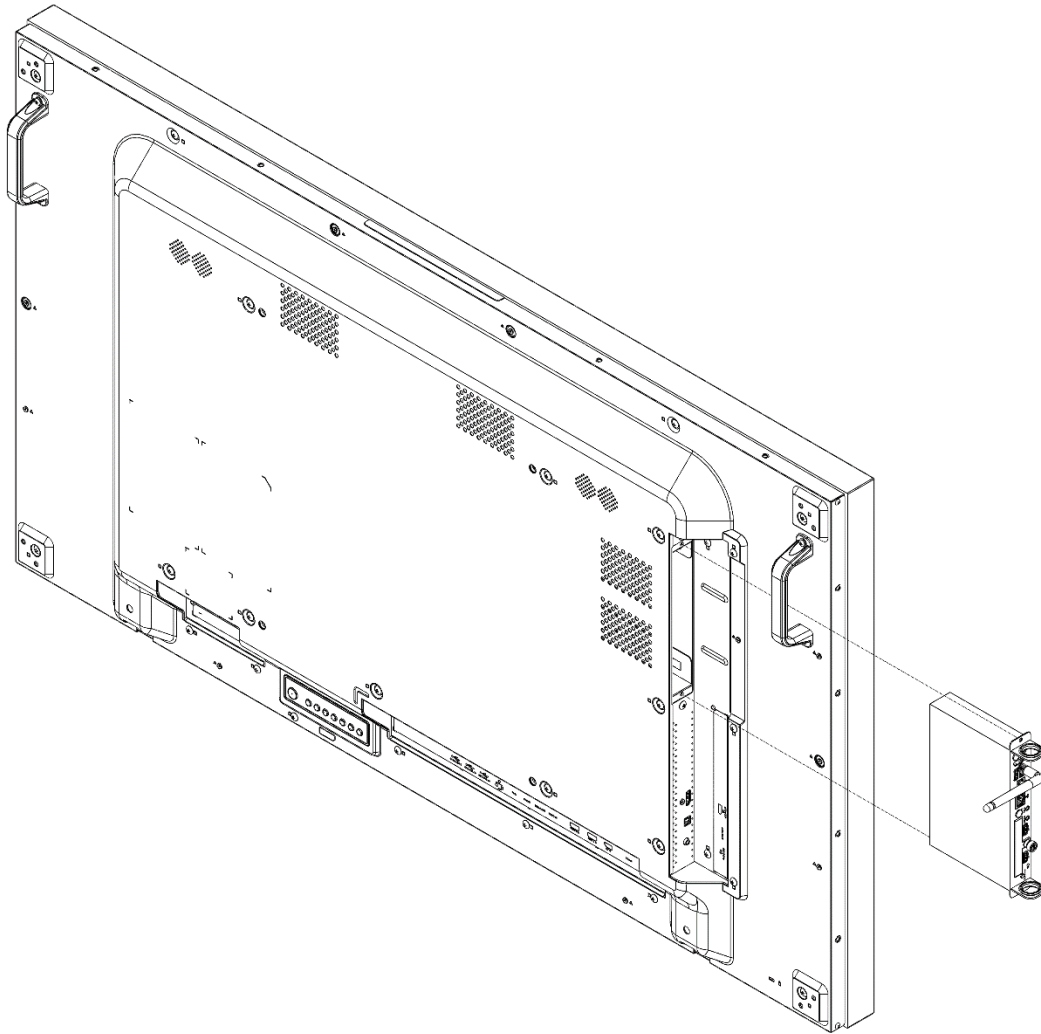

**Note:** The Planar VM Series was tested with the Philips CRD50 OPS module.

## 10. Installing Cosmetic Trim (Optional)

Cosmetic trim kits for each display edge are available for purchase as an optional accessory. Secure each trim piece to the edge of the display using the included screws.

**Note:** In some models, the cosmetic trim pieces are different for each edge, and for some models, the cosmetic trim pieces are the same for each edge. Also, in some cases, the screw length may vary for some trim pieces. Take care to ensure that the proper trim piece is connected to the correct edge of the display, and that the correct screw is used for each trim piece.

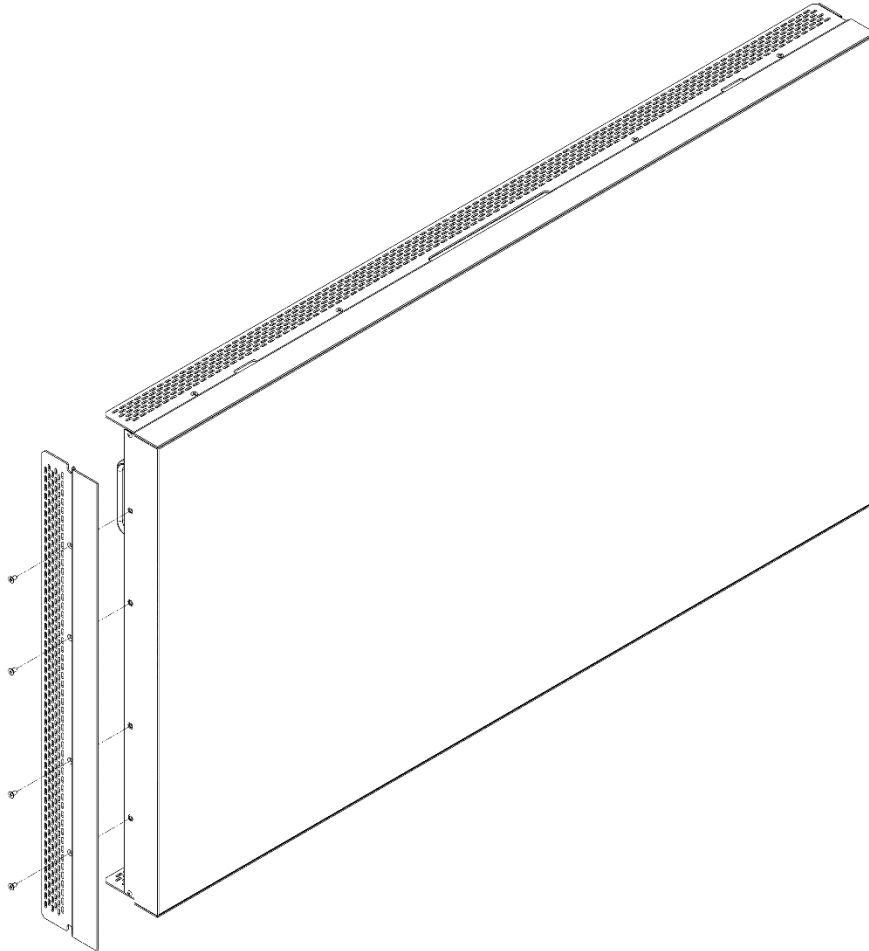

# Operating the Display

## 11. OSD Keypad

The OSD keypad is located on the rear of the display.

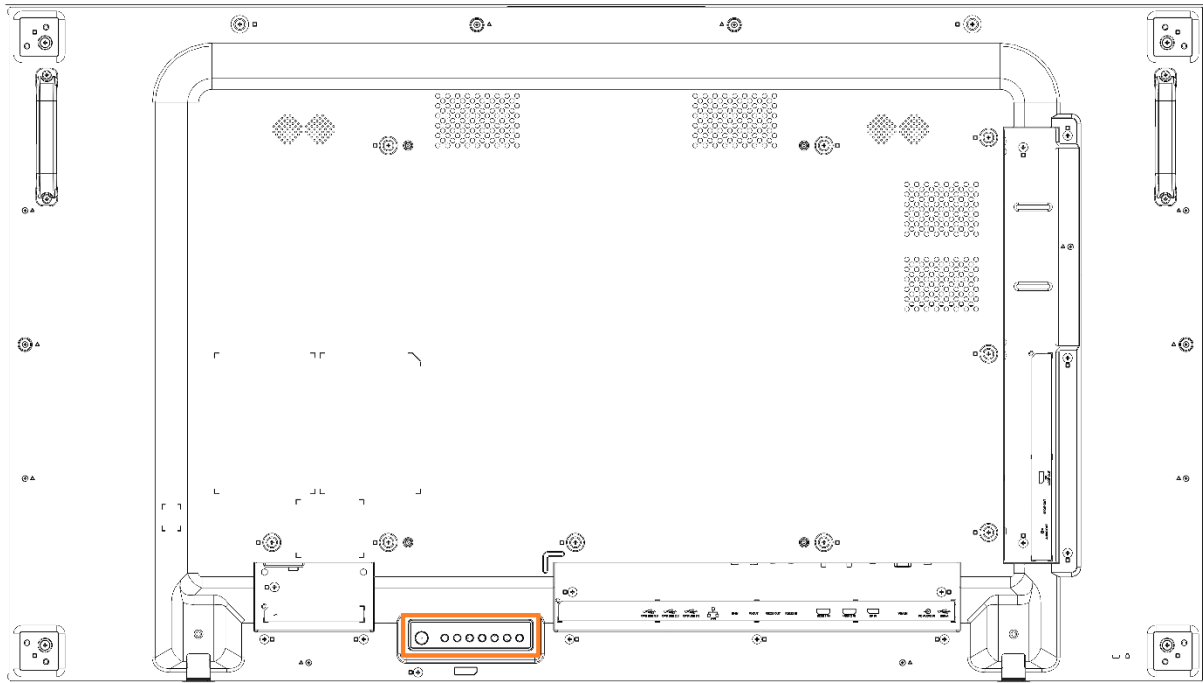

**OSD Keypad Buttons**

Key	Descriptions
Power	Power on / Power off
Mute	Audio Mute
Input	Source Selection
+	Menu Right / Increase value / Volume +
-	Menu Left / Decrease value / Volume -
▲	Menu Up
▼	Menu Down
Menu	Menu open / close

## 12. LED Indicators

The LED indicator light is located on the rear of the display near the keypad. The following table explains what the different colors and blink patterns mean.

<b>LED On</b>	
<b>Power Status</b>	<b>Condition</b>
Green	Power on
Red	Standby Power save mode
Red / Green Blinking	IR codes received
Off	AC off

## 13. Using the Display in Flat or Tilted Orientation

The display is not recommended for use in flat orientation for tabletop, floor, or ceiling installations. LCD panels of this size are at risk of panel deflection, which can cause cosmetic sagging, brightness uniformity issues, and a shortened life span. Installations where the display is tilted downward or upward at an angle may also be prone to these issues and are not recommended.

**Note:** Failure to follow these instructions will void the warranty.

# 14. Using the Remote Control

Below is a picture of the remote control and its corresponding hex codes. See the following page for button descriptions and hex codes.

IR Remote Key Codes		
Key Name	Address	Data
Power	0x00	0x0C
Normal	N/A	N/A
ID	N/A	N/A
◀◀	0x00	0x2B
▶	0x00	0x2C
▶▶	0x00	0x28
■	0x00	0x31
⏸	0x00	0x30
Source	0x00	0x38
Home	0x00	0x54
Format	0x00	0xF5
Back	0x00	0x0A
List	0x00	0xCC
Info	0x00	0x0F
Up	0x00	0x58
Down	0x00	0x59
Left	0x00	0x5A
Right	0x00	0x5B
OK	0x00	0x5C
Adjust	0x00	0x90
Options	0x00	0x40
Vol +	0x00	0x10
Vol -	0x00	0x11
Mute	0x00	0x0D
[Red]	0x00	0x6D
[Green]	0x00	0x6E
[Yellow]	0x00	0x6F
[Blue]	0x00	0x70
1	0x00	0x01
2	0x00	0x02
3	0x00	0x03
4	0x00	0x04
5	0x00	0x05
6	0x00	0x06
7	0x00	0x07
8	0x00	0x08
9	0x00	0x09
0	0x00	0x00
ID Set	N/A	N/A
Enter	N/A	N/A
On	0x00	0x3E
Off	0x00	0x3F
HDMI 1	0x00	0x39
HDMI 2	0x00	0x3A
DP	0x00	0x3B
VGA	0x00	0x3C
OPS	0x00	0x3D

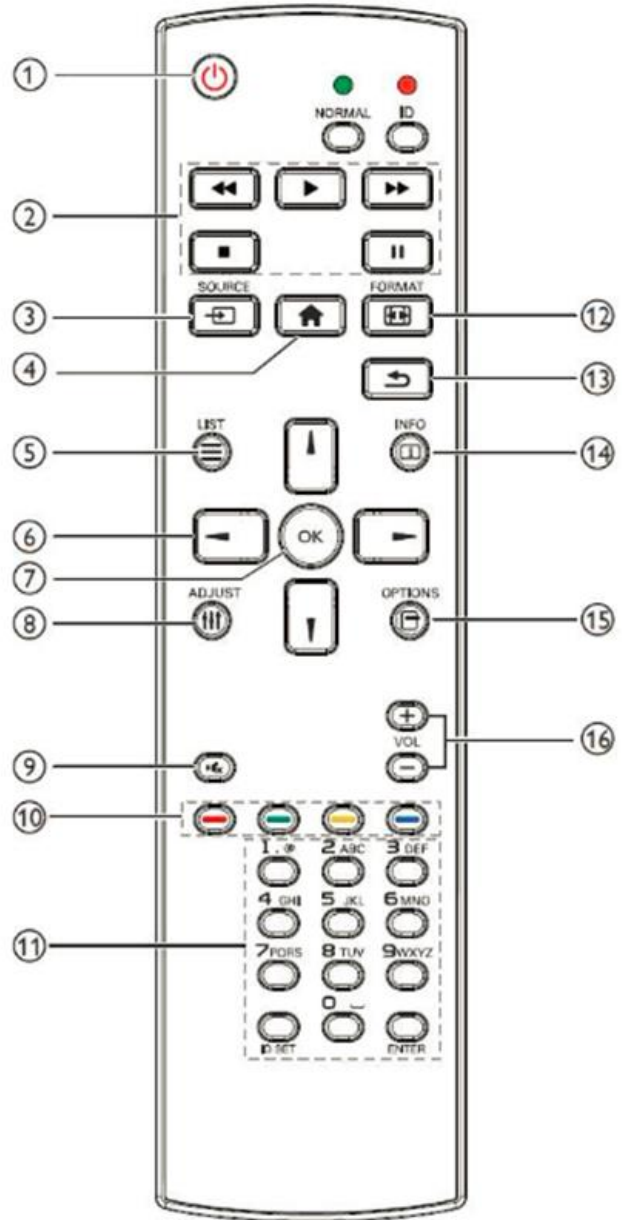

## 15. Pairing the Remote Control to the Display

The remote control can send commands to any display or to one specific display.

**To send commands to all displays:** Hold down the NORMAL button on the remote control until the green LED lights. When NORMAL mode is active, the green LED above the NORMAL button will blink when any key on the remote control is pressed.

**To send commands to only one display:** Hold down the ID button on the remote control until the red LED lights. When the ID mode is active, the red LED above the ID button will blink when any key on the remote control is pressed.

For initial setup of ID mode, perform the following steps:

1. In the OSD, change the Monitor ID setting to a unique value (see page 46).
2. On the remote control, hold down the ID SET button until the red LED above the ID button turns on.
3. Use the 0-9 keys to enter the same value selected for the Monitor ID setting. Press the ENTER key. The red LED will blink twice to confirm the ID code was successfully accepted. The remote control will automatically change to ID mode.
4. Test that the pairing is successful by pressing a remote control key, such as the HOME key. If the key is not accepted by the display, check the Monitor ID setting in the OSD matches the ID code selected on the remote control.



## 16. Basic Remote Functions

### 16.1 Turning the Display On

1. Insert the power cord into the display and into the power outlet.
2. Ensure the AC switch is set to “I”.
3. Press the power button on the remote or keypad.

### 16.2 Turning the Display Off

With the power on, press the power button on the remote or keypad to put the LCD panel in a standby mode. To turn off power completely, turn the AC switch to “O” or disconnect the AC power cord from the power outlet.

**Note:** If there is no signal for a certain period of time, the LCD panel will automatically go into standby mode.

### 16.3 Adjusting the Volume

1. Using the remote, press the VOL- or VOL+ to increase or decrease the volume.
2. Pressing the MUTE button temporarily turns off all sound. To restore the sound, press the MUTE button again.

**Note:** The analog audio out is variable. S/PDIF is fixed.

### 16.4 Selecting the Input Source

Press the SOURCE button on the remote or press the INPUT button on the keypad. Use the arrow buttons to select one of the following input sources and press OK:

- DisplayPort, HDMI 1, HDMI 2, OPS, VGA

**Note:** When the display cannot find a source, a “No signal” message will appear.

### 16.5 Navigating Through the Menus

1. With the power on, press MENU. The main menu appears.
2. Within the menu, use ▲, ▼, ◀, ▶, and OK to navigate through the menus and adjust options.
3. Press BACK to return to the previous menu. To exit the menu system, press HOME.

# 17. OSD Main Menu

## 17.1 Picture

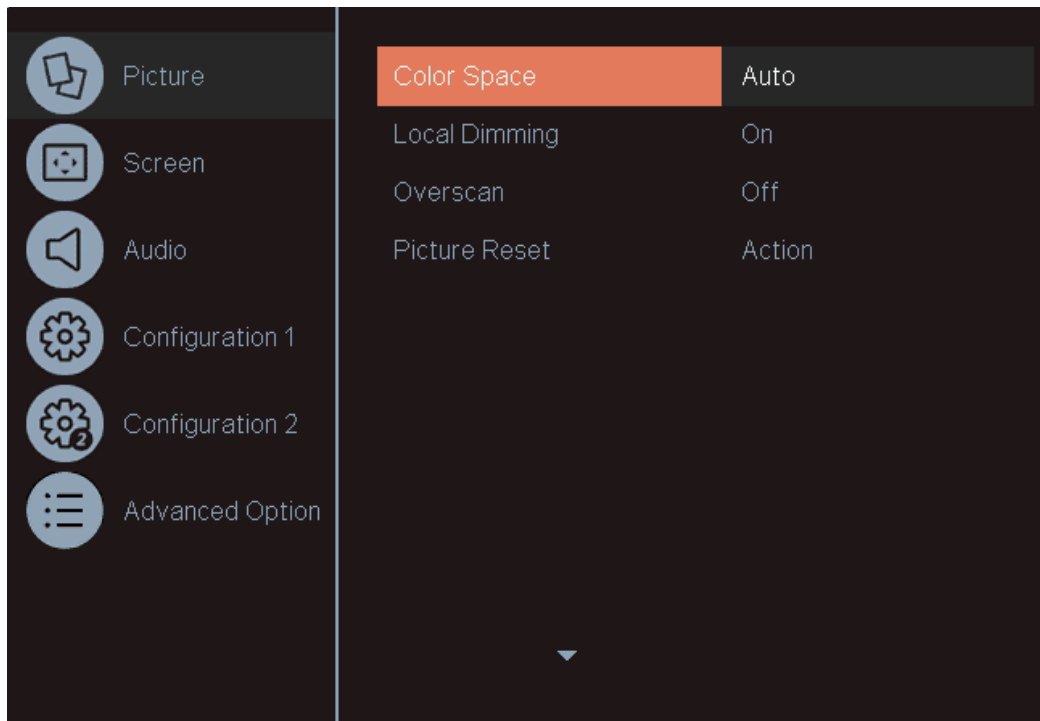
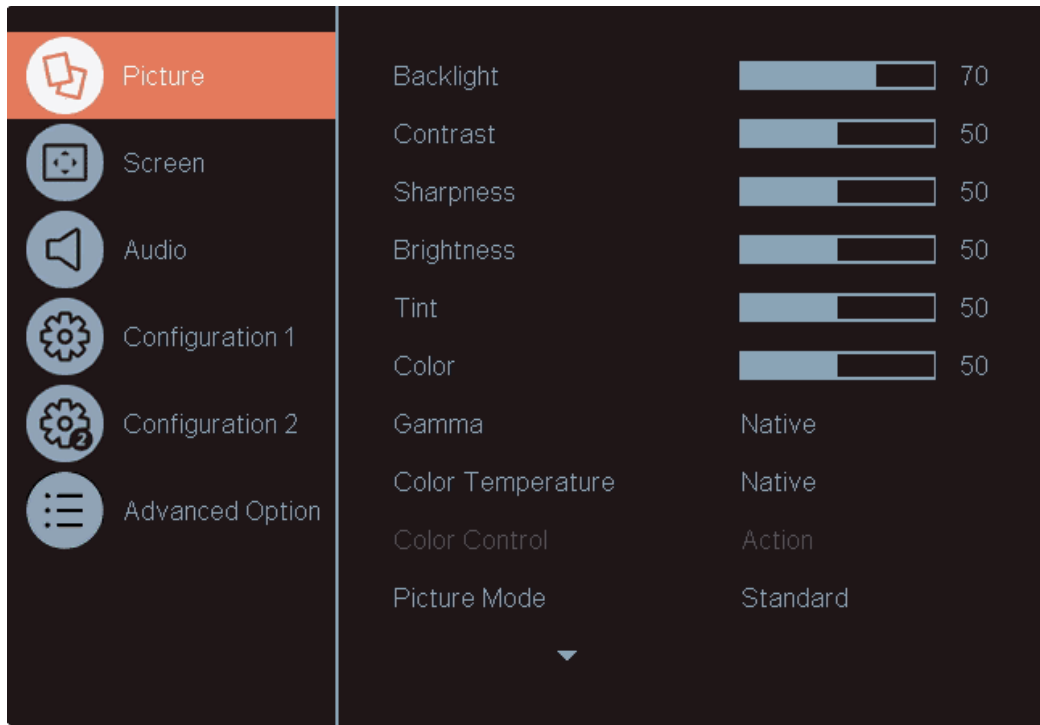

### Backlight

- Increase or decrease the intensity of the LCD backlight. Press ◀ or ▶ to select the desired level.
- **Range:** 0~100
- **Default:** 70

### Contrast

- Increase or decrease the contrast of the picture. Press ◀ or ▶ to select the desired level.
- **Range:** 0~100
- **Default:** 50

### Sharpness

- Adjust the definition of the picture. Press ◀ or ▶ to select the desired level.
- **Range:** 0~100
- **Default:** 50

### Brightness

- Increase or decrease the brightness of the picture. Press ◀ or ▶ to select the desired level.
- **Range:** 0~100
- **Default:** 50

### Tint

- Increase or decrease the green hue. Press ◀ or ▶ to select the desired level.
- **Range:** 0~100
- **Default:** 50

### Color

- Adjust the brilliance and brightness. Press ◀ or ▶ to select the desired level.
- **Range:** 0~100
- **Default:** 50

### Gamma

- Select gamma.
- **Options:** Native, 1.8~2.60
- **Default:** Native

### Color Temperature

- Select color temperature.
- **Options:** 3200K, 5500K, 6500K, 7500K, 9300K, Native, User 1, User 2
- **Default:** Native

## Color Control

- Enabled when “User 1” or “User2” is selected for the Color Temperature Setting.
- User 1:

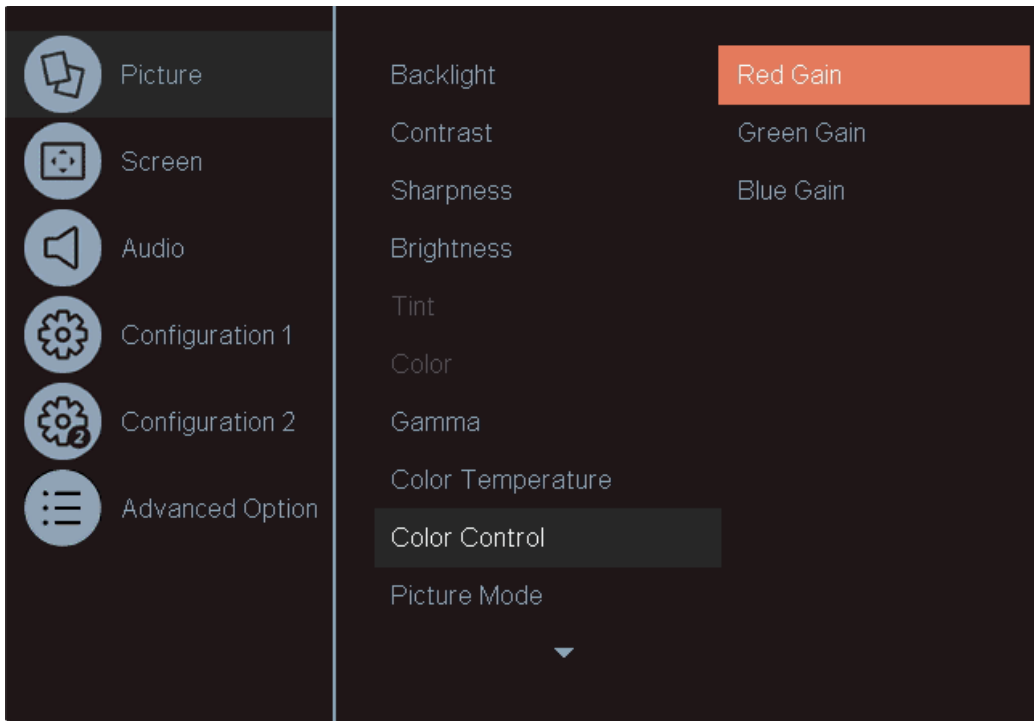

- Red Gain
  - Adjust the amount of red in bright content. Press ◀ or ▶ to select the desired level.
  - **Range:** 0~255
  - **Default:** 255
- Green Gain
  - Adjust the amount of green in bright content. Press ◀ or ▶ to select the desired level.
  - **Range:** 0~255
  - **Default:** 255
- Blue Gain
  - Adjust the amount of blue in bright content. Press ◀ or ▶ to select the desired level.
  - **Range:** 0~255
  - **Default:** 255

- User 2:

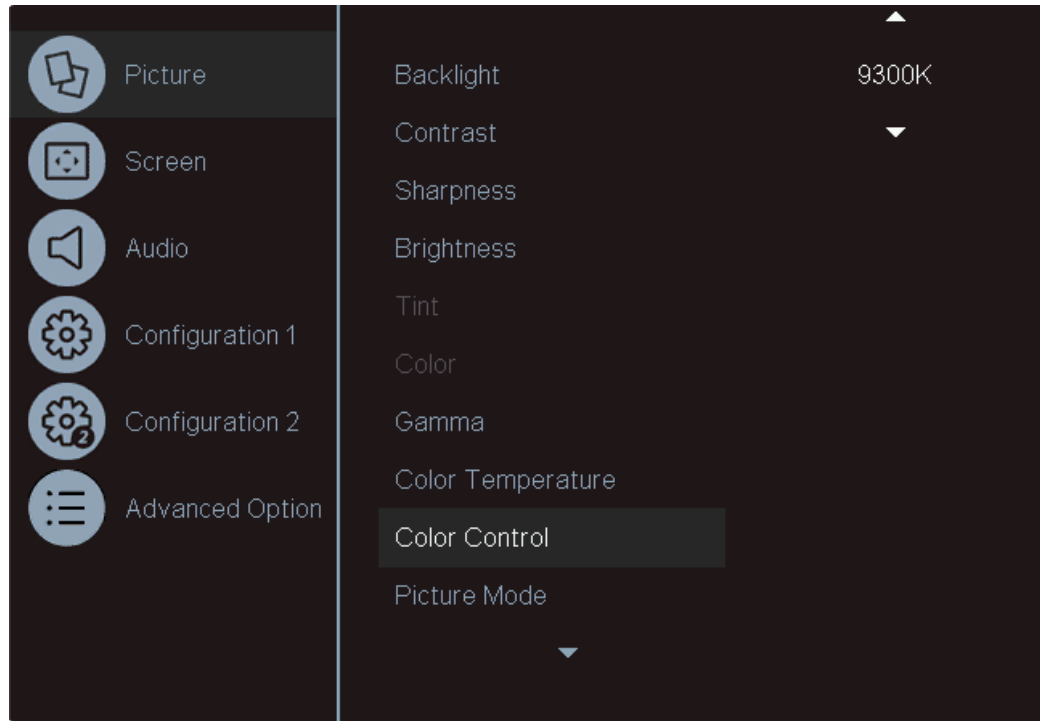

- Select a specific color temperature.
- **Range:** 3200K~9300K (increments on 100K)
- **Default:** 9300K

#### Picture Mode

- Select a set of preset values for the picture settings.
- **Options:** Standard, Highbright, Cinema, sRGB
- **Default:** Standard

#### Color Space

- Select the input color space encoding for HDMI and DisplayPort inputs.
- **Options:** RGB PC, RGB Video, REC601, REC709, Auto
- **Default:** Auto

#### Local Dimming

- Enable local dimming of the LCD backlight. This improves black levels and contrast; however, for some content it may introduce artifacts.
- **Options:** Off, On
- **Default:** Off

#### Overscan

- Adjust the zoom (overscan) of the image.
- **Options:** Off, On
- **Default:** Off

#### Picture Reset

- Reset all setting in the Picture menu to their default values.

## 17.2 Screen



### H Position

- Adjust the horizontal position of the image (VGA source only). Press ◀ or ▶ to select the desired level.
- **Range:** 0~100
- **Default:** 50

### V Position

- Adjust the vertical position of the image (VGA source only). Press ◀ or ▶ to select the desired level.
- **Range:** 0~100
- **Default:** 50

### Tracking

- Adjust the clock of the displayed signal (VGA source only). Press ◀ or ▶ to select the desired level.
- **Range:** 0~100
- **Default:** 50

### Phase

- Adjust the phase of the displayed signal (VGA source only). Press ◀ or ▶ to select the desired level.
- **Range:** 0~100
- **Default:** 50

### Aspect Ratio

- Adjust the aspect ratio of the screen.
- **Options:** Fill, 4:3, Native, 16:9, Letterbox
- **Default:** Fill

### Auto Adjust

- Force the display to reacquire and lock to the input signal (VGA source only). This is useful when the signal quality is marginal.
- **Note:** This feature does not continually reacquire the signal.

### Screen Reset

- Reset all settings in the Screen menu to their default values.

## 17.3 Audio

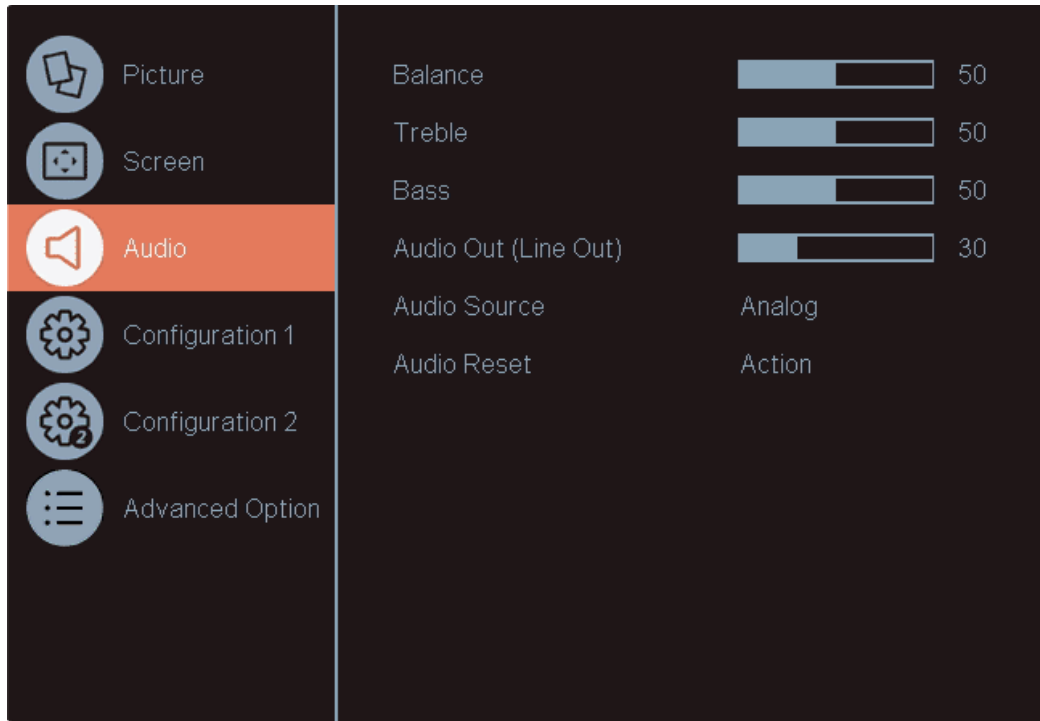

### Balance

- Adjust the balance of the left and right speakers. Press ◀ or ▶ to select the desired level.
- **Range:** 0~100
- **Default:** 50

### Treble

- Adjust the sound in high tones. Press ◀ or ▶ to select the desired level.
- **Range:** 0~100
- **Default:** 50

### Bass

- Adjust the sound in low tones. Press ◀ or ▶ to select the desired level.
- **Range:** 0~100
- **Default:** 50

### Audio Out (Line Out)

- Adjust the volume for the Line Out connector on the display. Press ◀ or ▶ to select the desired level.
- **Range:** 0~100
- **Default:** 30



### Audio Source

- Select the audio source to play through the display's internal speakers and audio outputs.
- **Options:** Analog, DisplayPort, Digital
- **Default:** Analog for VGA, Digital for all other sources
- **Note:** The Digital option cannot be selected for DisplayPort and the DisplayPort option cannot be selected for Digital.

### Audio Reset

- Reset all settings in the Audio menu to their default values.

## 17.4 Configuration 1

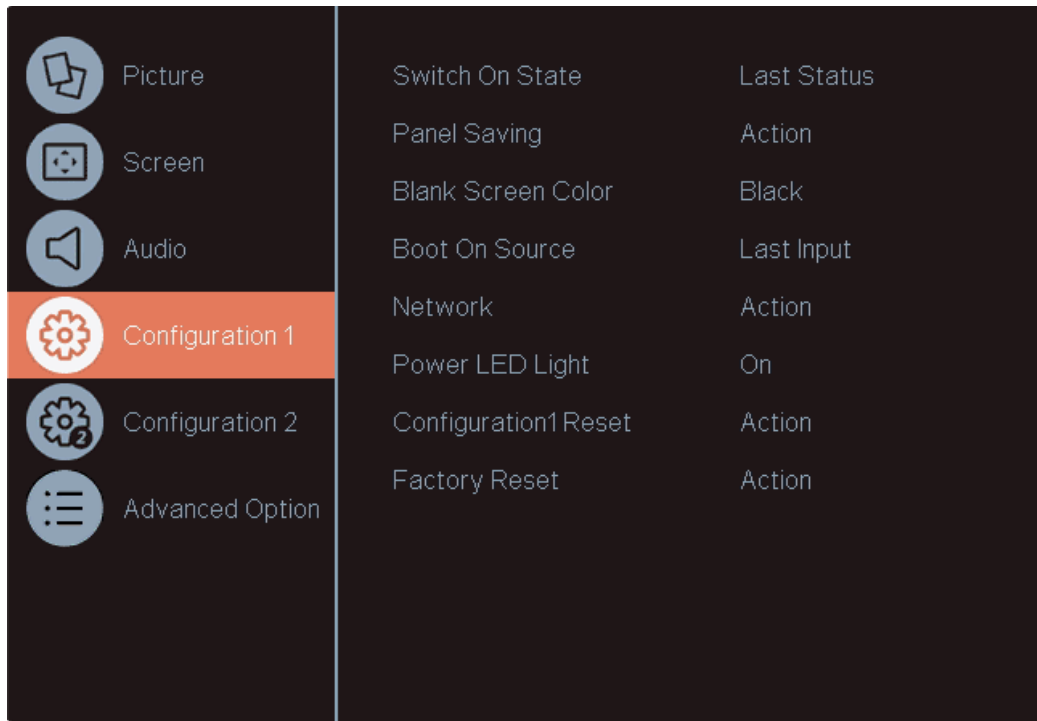

### Switch On State

- Select the behavior of the display when AC power is turned on.
- **Options:** Power Off, Force On, Last Status
- **Default:** Last Status

### Panel Saving

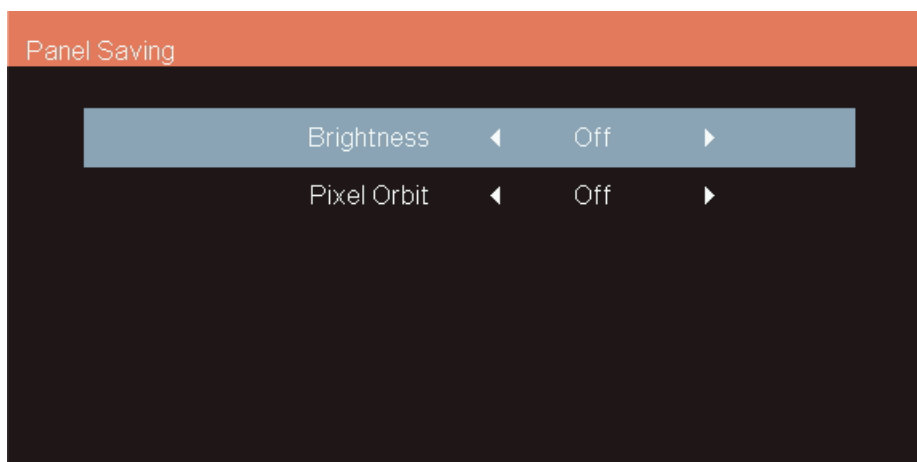

- **Brightness**
  - Automatically limit the backlight intensity in order to reduce power consumption.
  - **Options:** Off, On
  - **Default:** Off

- Pixel Orbit
  - Create slight frame motion to help avoid image retention.
  - **Options:** Off, On
  - **Default:** Off

#### Blank Screen Color

- Set the color that is displayed when no signal is present on the selected input.
- **Options:** Black, Blue
- **Default:** Black

#### Boot On Source

- Select the source to display on power up.
- **Options:** Last Input, DisplayPort, HDMI 1, HDMI 2, OPS, VGA
- **Default:** Last Input

#### Network

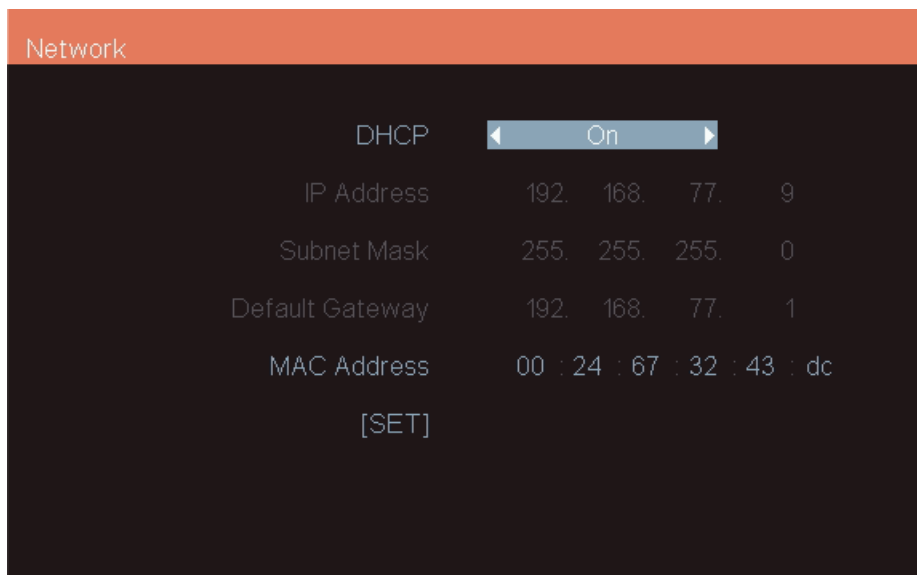

- DHCP
  - Enable dynamic IP mode or configure the static IP settings of the display's Ethernet port.
  - **Options:** On, Off.
  - **Default:** On
- IP Address
  - The IP address used by the display's network interface. Configurable if DHCP is set to Off.
- Subnet Mask
  - The subnet mask used by the display's network interface. Configurable if DHCP is set to Off.
- DNS Address
  - The address of the DNS server used by the display's network interface. Configurable if DHCP is set to Off.

- **Default Gateway**
  - The default gateway used by the display's network interface. Configurable if DHCP is set to Off.
- **MAC Address**
  - The MAC address of the display's network interface.

#### Power LED Light

- Enable or disable the power LED.
- **Options:** Off, On
- **Default:** On

#### Configuration 1 Reset

- Reset all settings in the Configuration 1 menu to their default values.

#### Factory Reset

- Reset all settings in all menus to their default values.

## 17.5 Configuration 2

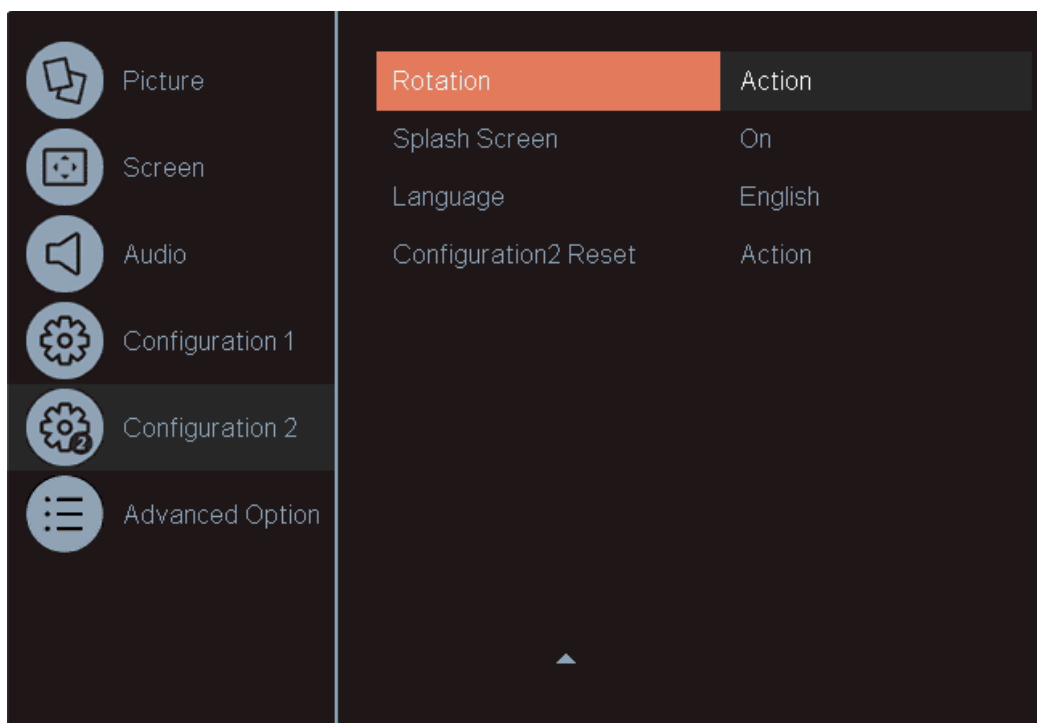

### OSD Turn Off

- Adjust the time in seconds before the OSD menu disappears. Press ◀ or ▶ to select the desired level.
- **Range:** Off, 5~120 seconds
- **Default:** 45

### OSD H Position

- Adjust the horizontal position of the OSD menu. Press ◀ or ▶ to select the desired level.
- **Range:** 0~100
- **Default:** 50

### OSD V Position

- Adjust the vertical position of the OSD menu. Press ◀ or ▶ to select the desired level.
- **Range:** 0~100
- **Default:** 50

### OSD Transparency

- Adjust the transparency of the OSD menu. Press ◀ or ▶ to select the desired level.
- **Options:** Off, 1~4
- **Default:** Off

### Information OSD

- Apply to all pop-ups and menus that are not the main OSD (for example, mute status, volume, and timing information). Press ◀ or ▶ to select the desired level.
- **Options:** Off, 1~60 seconds
- **Default:** 10

### Monitor ID

- Set the ID to use with both the IR remote control in ID mode and RS232 serial commands. See page 32 for more information. Press ◀ or ▶ to select the desired level.
- **Options:** 1~255
- **Default:** 1

### Heat Status

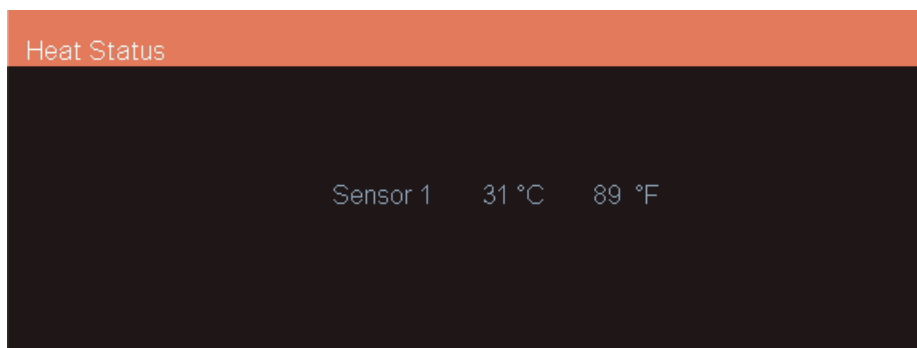

- Read the internal temperature of the display.

## Monitor Information

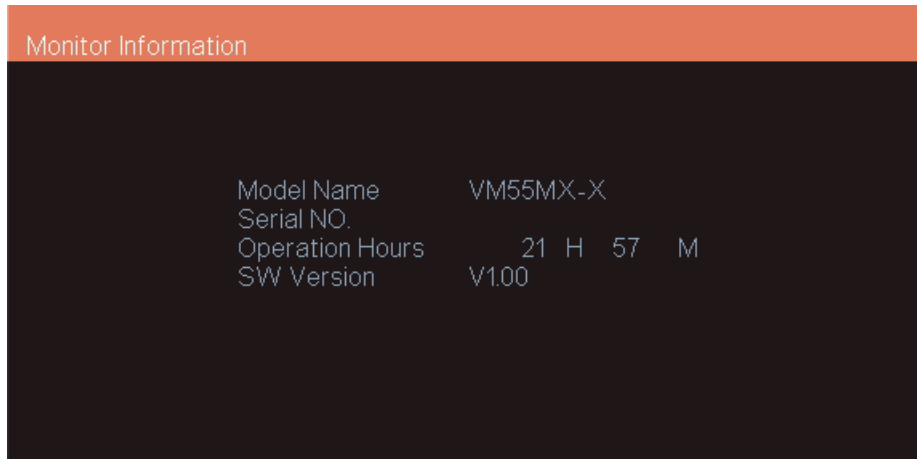

- This read-only menu provides information on the display and its firmware version

### DP Version

- Select which DisplayPort standard to use on the DisplayPort input.
- **Options:** DP 1.1, DP 1.2
- **Default:** DP 1.2

### HDMI Version

- Set the EDID on the currently selected HDMI input to match the desired version of the HDMI standard.
- **Options:** 1.4, 2.0
- **Default:** 2.0
- **Note:** HDMI 2.0 is the more modern standard and supports 3840x2160 @ 60Hz resolution. However, sometimes HDMI 1.4 is needed for compatibility with older devices.

### Rotation

- Rotate the OSD for use in either landscape or portrait orientation.
- **Note:** This rotates only the OSD, not the image.
- **Options:** Landscape, Portrait

### Splash Screen

- Select whether a splash screen appears when the monitor powers up.
- **Options:** Off, On
- **Default:** On

### Language

- Select the OSD language.
- **Options:** English, French, German, Spanish, Italian, Simplified Chinese, Traditional Chinese, Japanese, Portuguese
- **Default:** English

### Configuration 2 Reset

- Resets all settings in the Configuration 2 menu to their default values.

## 17.6 Advanced Option

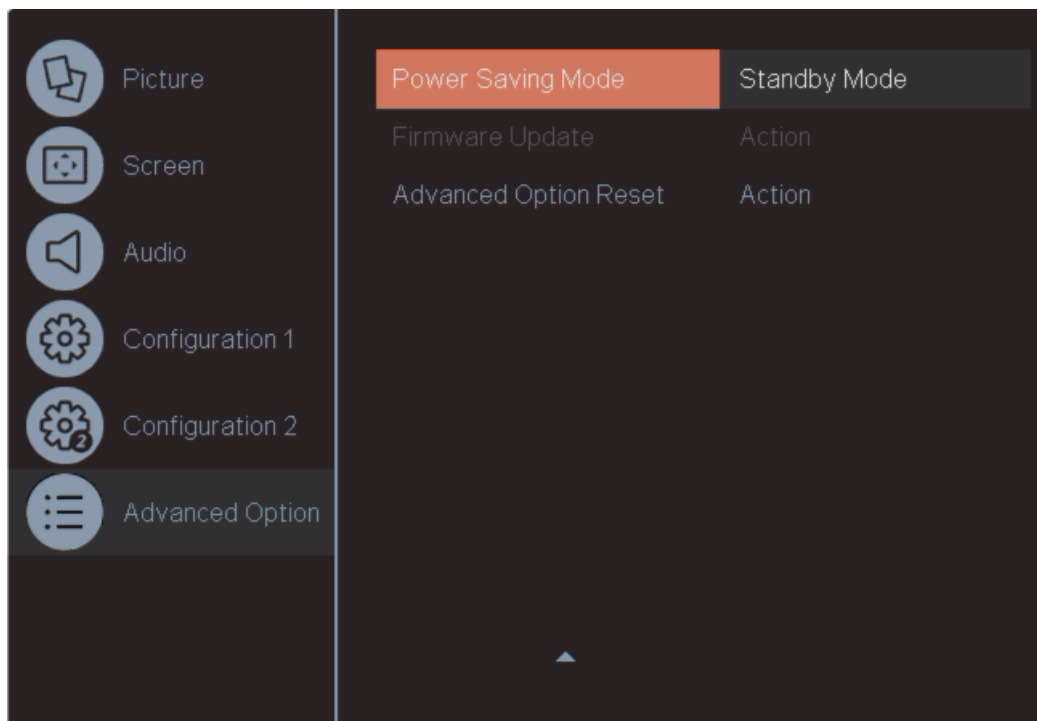
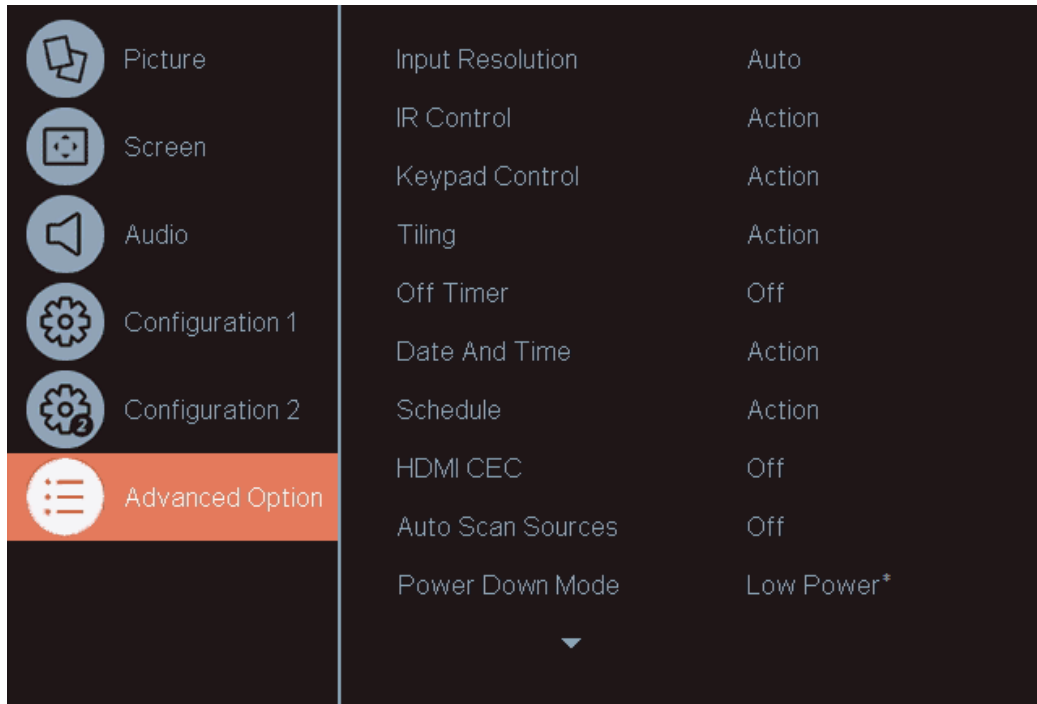

### Input Resolution

- Select the VGA input timing. Some video formats look too similar to other formats, preventing automatic detection and requiring manual format selection. In most cases, this setting will not need to be changed from Auto.
- **Options:** Auto, 1024x768, 1280x768, 1360x768, 1366x768
- **Default:** Auto



## IR Control

- Lock or unlock IR remote control functionality. To disable the IR remote lock, press the Info key for 10 seconds.
- **Options:** Normal, Primary, Secondary, Lock All, Lock all but Volume, Lock All but Power
- **Default:** Normal

## Keypad Control

- Lock or unlock the keypad controls.
- **Options:** Unlock, Lock All, Lock all but Volume, Lock All but Power
- **Default:** Unlock

## Tiling



- H Monitors
  - Indicate the number of displays horizontally in the tiled wall.
  - **Options:** 1~15
  - **Default:** 1
- V Monitors
  - Indicate the number of displays vertically in the tiled wall.
  - **Options:** 1~15
  - **Default:** 1

- Position
  - Select the location of this display within the tiled wall.
  - **Options:** Varies depending on the values of H Monitors and V Monitors
  - **Default:** 1
- Frame Comp. Top / Bottom / Left / Right
  - Select the number of lines/pixels to remove from each edge of the display to compensate for the display's bezel.
  - **Options:** 1~100
  - **Default:** 1
- Frame Comp.
  - Scale the image to compensate for the width of the display's bezel. Use the Frame Comp. Top / Bottom / Left / Right controls to determine how much of the image should be removed on each edge.
  - **Options:** Off, On
  - **Default:** Off
- Enable
  - Apply the tiling mode settings to the display.
  - **Options:** Off, On
  - **Default:** Off
- Switch On Delay
  - Select the amount of time to delay before turning on the display. Depending on the electrical capabilities at the installation site, it can be necessary to adjust the power on sequence of the displays. Use this control to ensure that each display will power on at a different time, avoiding such problems.
  - **Options:** Off, Auto, 0.1~25.0 seconds in 0.1 second increments
  - **Default:** Off
- Save To Preset
  - Select a preset for saving the tiling parameters.
  - **Options:** 1~10
  - **Default:** 1
- Save Action
  - Save the tiling parameters to the selected preset.
- Recall From Preset
  - Select a preset for restoring the tiling parameters.
  - **Options:** 1~10
  - **Default:** 1
- Recall Action
  - Recall the tiling parameters from the selected preset.

#### Off Timer

- Force the display to enter standby mode after the specified period of time. Press ◀ or ▶ to select the desired level.
- **Options:** Off, 1~24 hours
- **Default:** Off

## Date and Time

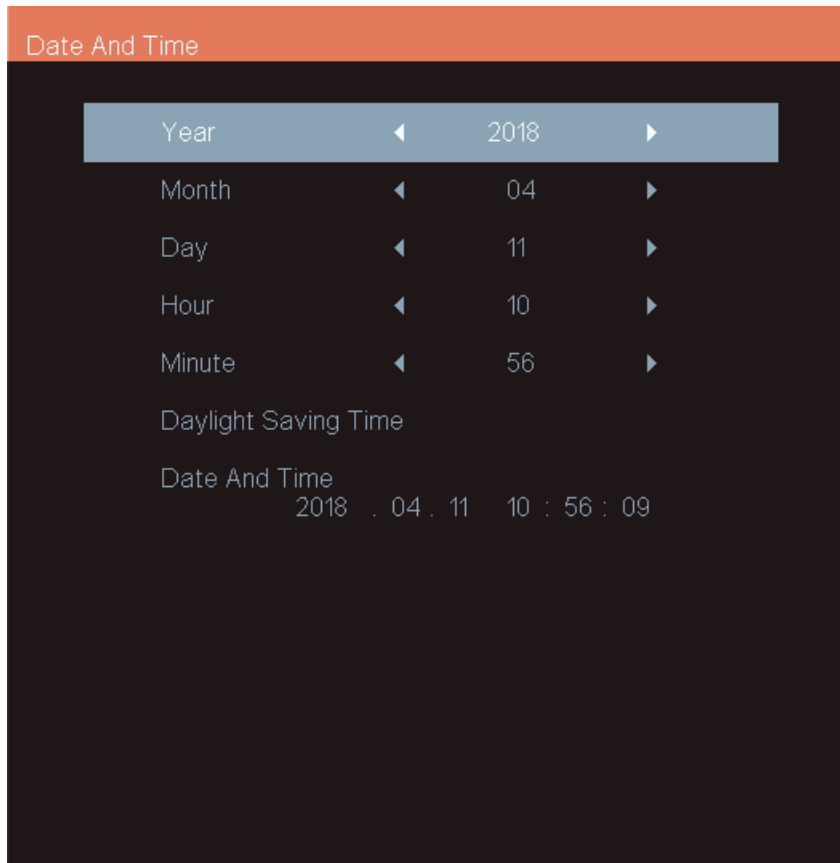

- Year / Month / Day / Hour / Minute
  - Set the current date and time.
- Daylight Saving Time

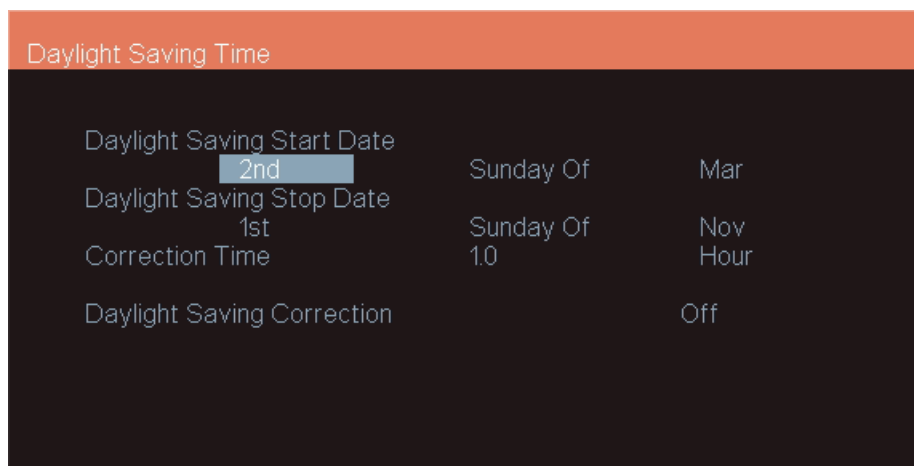

- Enable or disable Daylight Saving Time, and select the effective dates.
- Date and Time
  - Displays the current date and time configured in the display.

## Schedule

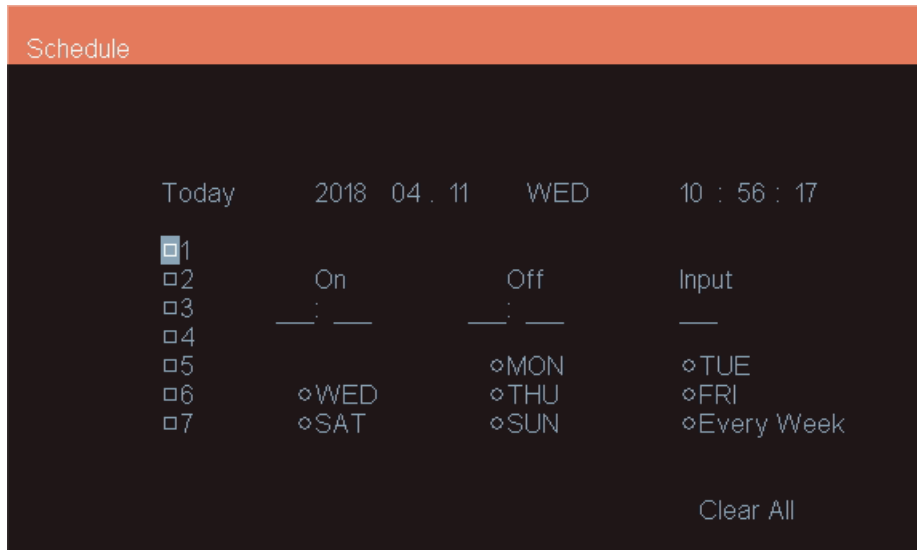

- This menu is used to configure schedules for powering on and powering off the display at preset times. Up to seven different schedules can be set.
- Schedule List
  - Select the schedule preset to configure.
  - **Range:** 1~7
  - **Default:** 1
- Enable
  - Make the selected schedule active. Available when On, Off, Input and Days of the Week are configured.
  - **Options:** Off, On
  - **Default:** Off
- On
  - Set the time when the display will power on.
- Off
  - Set the time when the display will enter standby mode.
- Days of the Week
  - Select which days of the week the selected schedule is active.
  - **Options:** Sun, Mon, Tue, Wed, Thu, Fri, Sat
  - **Default:** None
- Every Week
  - Indicate whether the schedule is for the current week only, or for every week going forward.
  - **Options:** Off, On
  - **Default:** Off

## HDMI CEC

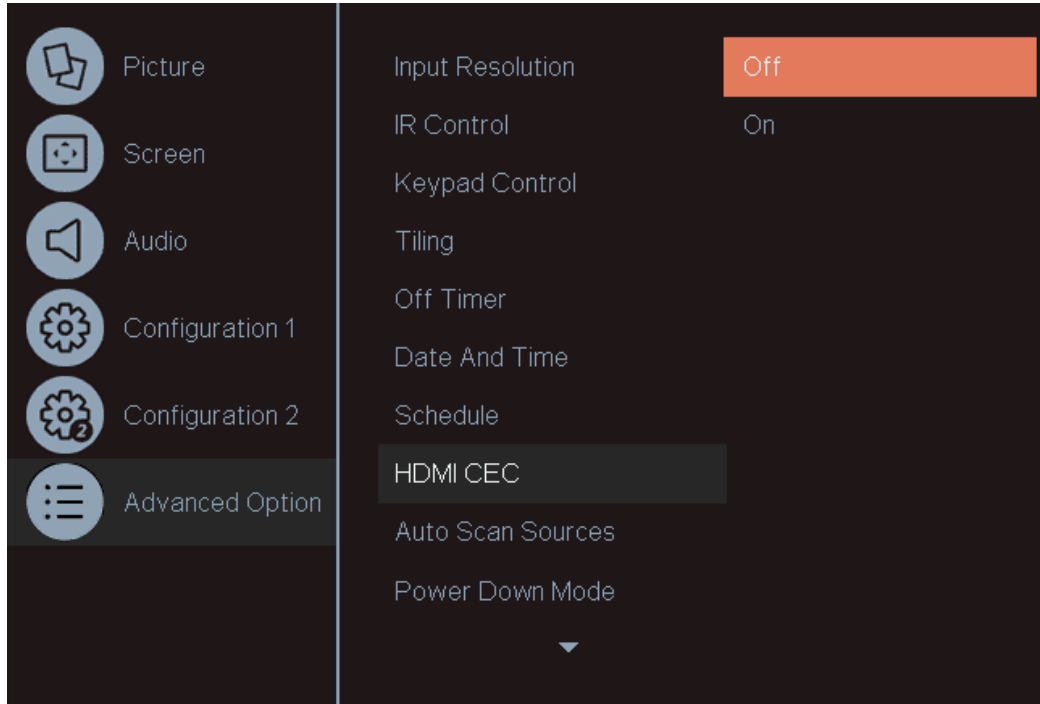

- Enable the HDMI CEC functionality.
- **Note:** Only the commands listed in the table below are implemented. Sources that require other commands may encounter compatibility issues. It is recommended to leave CEC disabled unless all CEC commands from the source are implemented.

## Supported HDMI CEC Commands

Command	Value	Notes
Text View On	0x0D	
Standby	0x36	
User Control Pressed	0x44	Power key only (Data value 0x40)
Active Source	0x82	
Give Device Power Status	0x8F	

- **Options:** Off, On
- **Default:** Off

## Auto Scan Sources

- Select to scan inputs in order until a valid signal is detected. Continue scanning when the signal on the selected input is lost.
- **Options:** Off, On
- **Default:** Off

## Power Down Mode

- Select the behavior of the display in standby mode.
- **Options:** Lower Power, Fast Startup
- **Default:** Low Power

### Power Saving Mode

- Select the behavior of the unit when no signal is detected.
- **Options:** Standby Mode, Networked Standby Mode, Wake on Signal, Fast Wake on Signal, Always On
- **Default:** Standby Mode
- **Note:** Full networking support in standby is available in the Networked Standby Mode, Wake on Signal, Fast Wake on Signal and Always On selections. Standby Mode does not support networking in standby.

### Firmware Update

- Update the display's firmware from a USB flash drive. See the firmware upgrade instructions within the firmware package for more information.

### Advanced Settings Reset

- Resets all settings in the Advanced Settings menu to their default values.

## 18. Tiling Configuration

When using the VM Series displays in a tiled configuration, configure the displays by performing steps in the following order:

1. **Cabling:** Daisy-chained wiring of video and communication connections. See section 8.8 (page 24).
2. **Layout:** Tiled wall size and position of each panel. See section 18.1 (page 55).
3. **Source Configuration:** Selection of the proper input connection on each panel. See section 16.4 (page 33).
4. **Color Balance:** Adjustment of adjacent displays to ensure that they match in color. See section 18.2 (page 56).
5. **Frame Compensation:** Adjustment of the tiled image to compensate for the bezel width and gap between panels. See section 18.3 (page 58).

**Note:** This section discusses how to display one image across the entire wall. However, more complex tiling setup is also possible by configuring the parameters differently for different subsections of the wall.

### 18.1 Layout

Configure the following parameters in the Tiling menu (see page 49). These values will be the same on all displays.

- **H Monitors:** The number of displays in the horizontal direction on the tiled wall
- **V Monitors:** The number of displays in the vertical direction on the tiled wall

Additionally, the Position parameter in the Tiling menu will need to be adjusted in each individual panel. The number represents the location of the panel when counting left-to-right, top-to-bottom, starting with the top left panel in the wall. Reference the example diagram below for a 3x4 wall.

H Monitors: 3 V Monitors: 4 Position: 1	H Monitors: 3 V Monitors: 4 Position: 2	H Monitors: 3 V Monitors: 4 Position: 3
H Monitors: 3 V Monitors: 4 Position: 4	H Monitors: 3 V Monitors: 4 Position: 5	H Monitors: 3 V Monitors: 4 Position: 6
H Monitors: 3 V Monitors: 4 Position: 7	H Monitors: 3 V Monitors: 4 Position: 8	H Monitors: 3 V Monitors: 4 Position: 9
H Monitors: 3 V Monitors: 4 Position: 10	H Monitors: 3 V Monitors: 4 Position: 11	H Monitors: 3 V Monitors: 4 Position: 12

## 18.2 Color Balance

Colors vary slightly from one display to the next, because of slight variations in the backlights and displays. This cannot be avoided, but can be compensated for with color balancing. The procedure can be performed either by eye or with a tristimulus colorimeter.

**Note:** The procedure below discusses how to perform color balancing by eye. Use of a tristimulus colorimeter is a more advanced procedure that may require the assistance of a calibration expert.

Color balancing by eye is subjective. It may seem strange at first, but it gets easier with practice. Fortunately, all of the colors do not need to be matched, only the whites and grays. It is not necessary to achieve a perfect white or a perfectly colorless gray. It is only necessary that all the displays look alike when they display white and gray.

**Caution:** Never try to match the colors of the displays with the black and white level controls or with the video controls.

**Caution:** Color blind individuals, even a little bit, should not color balance the array. Have someone else color balance the wall.

1. Turn on all the displays in the array and let them warm up for at least 5 minutes. The backlights must be thoroughly warm before doing color balance.
2. Set the global backlight level to the desired luminance by selecting a nominal value for Backlight in each display.

**Note:** Setting the Backlight value to less than 100 will allow some range for luminance adjustment in the brighter direction. Otherwise, the displays will have a limited adjustment range.

3. In each display, set the Color Temperature value to User 1. This allows for adjustment of the red, green and blue gain settings in later steps.
4. Connect a source to the wall and send a full white test pattern.
5. When all displays are white, find the least bright display in the array. This will typically be the “baseline” display and will not be adjusted. All other displays will be adjusted to this baseline display.

The least bright display is picked due to the ability to only adjust luminance down. When the RGB gain values are set to their default max values, the display is as bright as it can get. This step is adjusting for slight variations in backlight luminance.

6. Choose a display next to the baseline display and adjust its Backlight setting to make its overall luminance match the baseline display. (If adjusting down will not match the baseline, the darkest display may not have been chosen. Start the process again from step 7.)
7. Continue with other adjacent displays until the overall backlight luminance matches on all displays.

**Note:** The backlight adjustment does not affect the color of the display. Additionally, the color balance may only be good for the backlight intensity chosen. If the intensity for the final application will be different, the colors may not exactly match. It is always best to color balance for the intended application.

8. Choose a display next to the baseline display and adjust its gain values (red, green and blue) to make its color match the baseline display. Concentrate on the center of the displays, not the adjacent edges.



9. Continue with other adjacent displays until all the displays have the same appearance when white.

**Note:** White balance may be an iterative process where displays will need to be adjusted multiple times as other surrounding panels are adjusted.

10. If there is a need to start over, use the Picture Reset or Factory Reset features in the OSD. Refer to section 17 (page 34) for more information.

## 18.3 Frame Compensation

When video displays are used in an array, the intent is to display a large version of an image. However, even the thinnest of mullions can make the image appear incorrect. Notice the eagle's eye here.

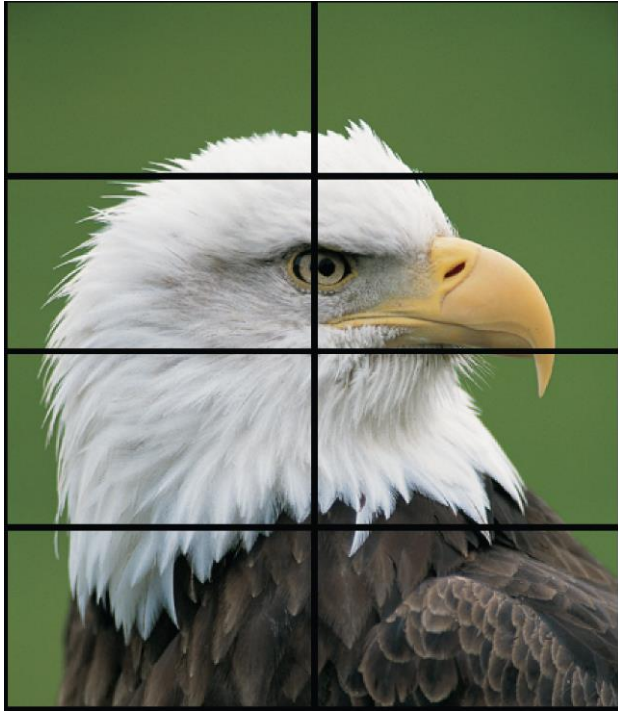

One way to fix this is to adjust the image. Imagine looking out a window made up of many panes of glass. The image seen is partially obscured by the frames, but the mind will assemble the image and ignore the frames.

**Note:** Frame Compensation is also known as mullion or bezel compensation.

Frame compensation basically mimics the mind's function by "hiding" portions of the picture (as if the mullions were actually hiding the image) and allow the distributed image to appear as one very large image.

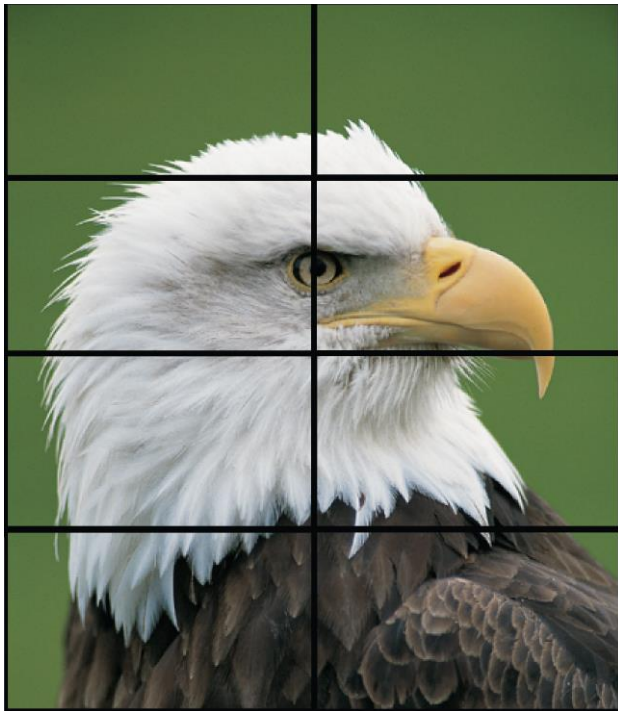

To ensure images containing diagonal lines remain correctly aligned, turn on Frame Compensation.

Depending on how closely each display image is to another will determine how much of the picture to “hide” behind the display’s mullions and the space between displays.

The Tiling menu in the OSD contains the frame compensation controls (see page 50). To adjust frame compensation, first set Frame Comp to On. For each of the top, bottom, left and right edges of the display, adjust the Frame Comp. Top, Frame Comp. Bottom, Frame Comp. Left and Frame Comp. Right settings, respectively, until the image looks correct.

**Note:** Start with the same settings for top and bottom, and the same settings for left and right. Make adjustments as needed to compensate for any variations in the gaps between displays.

# External Control

In addition to using the Planar VM Series remote control and display, there are other methods of controlling the Planar VM Series display externally:

- Using a serial link to send binary commands and to receive responses to those commands. The same set of commands can be sent over RS232 or TCP. See the *Planar VM Series RS232 User Manual* for more information.
- Using discrete infrared (IR) codes to program a third-party remote control.

# Signal Compatibility

Compatible Video Sources								
Signal Type	Resolution	Frame Rate (Hz)	Line Rate (kHz)	Pixel Rate (MHz)	HDMI + OPS	DisplayPort	VGA	References
PC	640x480	59.940	31.469	25.175	x	x	x	VESA DMT, CEA-861-F Format 1
	640x480	72.809	37.861	31.500	x	x	x	VESA DMT
	640x480	75.000	37.500	31.500	x	x	x	VESA DMT
	640x480	85.008	43.269	36.000	x	x	x	VESA DMT
	800x600	60.317	37.879	40.000	x	x	x	VESA DMT
	800x600	72.188	48.077	50.000	x	x	x	VESA DMT
	800x600	75.000	46.875	49.500	x	x	x	VESA DMT
	800x600	85.061	53.674	56.250	x	x	x	VESA DMT
	848x480	59.659	29.830	31.500	x	x	x	VESA CVT
	848x480	74.769	37.684	41.000	x	x	x	VESA CVT
	848x480	84.751	42.969	46.750	x	x	x	VESA CVT
	1024x768	60.004	48.363	65.000	x	x	x	VESA DMT
	1024x768	70.069	56.476	75.000	x	x	x	VESA DMT
	1024x768	75.029	60.023	78.750	x	x	x	VESA DMT
	1024x768	84.997	68.677	94.500	x	x	x	VESA DMT
	1152x864	70.012	63.851	94.500	x	x	x	VESA DMT
	1152x864	75.000	67.500	108.000	x	x	x	VESA DMT
	1152x864	84.999	77.094	121.500	x	x	x	VESA DMT
	1280x768	49.929	39.593	65.250	x	x	x	VESA CVT
	1280x768	59.995	47.396	68.250	x	x	x	VESA CVT-R
	1280x768	59.870	47.776	79.500	x	x	x	VESA CVT
	1280x768	74.893	60.289	102.250	x	x	x	VESA CVT
	1280x768	84.837	68.633	117.500	x	x	x	VESA CVT
	1280x960	60.000	60.000	108.000	x	x	x	VESA DMT
	1280x960	75	75.000	126.000	x	x	x	VESA DMT
	1280x960	85.002	85.938	148.500	x	x	x	VESA DMT
	1280x1024	60.020	63.981	108.000	x	x	x	VESA DMT
	1280x1024	75.025	79.976	135.000	x	x	x	VESA DMT
	1280x1024	85.024	91.146	157.500	x	x	x	VESA DMT
	1366x768	59.790	47.712	85.500	x	x	x	VESA DMT
	1400x1050	49.965	54.113	100.000	x	x	x	VESA CVT
	1400x1050	59.948	64.744	101.000	x	x	x	VESA CVT-R
	1400x1050	59.978	65.317	121.750	x	x	x	VESA CVT
	1400x1050	74.867	82.278	156.000	x	x	x	VESA CVT
	1600x1200	60.000	75.000	162.000	x	x	x	VESA DMT
	1920x1080	49.929	55.621	141.500	x	x	x	VESA CVT
	1920x1080	59.963	67.158	173.000	x	x	x	VESA CVT
	1920x1080	59.950	66.587	138.500	x	x	x	VESA CVT-R
	1920x1200	49.932	61.816	158.250	x	x	x	VESA CVT
	1920x1200	59.950	74.038	154.000	x	x	x	VESA CVT-R
	1680x1050	49.974	54.121	119.500	x	x	x	VESA CVT
	1680x1050	59.954	65.290	146.250	x	x	x	VESA CVT
	1920x2160	60.000	135.000	297.000	x	x		CEA-861-F, VIC 16, with vertical parameters doubled
	1920x2160	59.988	133.293	277.250	x	x		VESA CVT-R
	2560x1440	59.951	88.787	241.500	x	x		VESA CVT-R
	2560x1600	59.972	98.713	268.500	x	x		VESA CVT-R
	3840x1080	59.968	66.625	266.500	x	x		VESA CVT-R
	3840x2160	23.999	52.438	209.750	x	x		VESA CVT-R
	3840x2160	29.981	65.688	262.750	x	x		VESA CVT-R
	3840x2160	49.977	110.500	442.000	x	x		VESA CVT-R
3840x2160	59.997	133.313	533.250	x	x		VESA CVT-R	
SDTV	480i	59.940	15.734	27.000	x			CEA-770.2, CEA-861-F Formats 6 & 7
	576i	50	15.625	27.000	x			ITU-R BT.656, CEA-861-F Formats 21 & 22
EDTV	480p	59.940	31.469	27.000	x	x	x	CEA-770.2, CEA-861-F Formats 2 & 3
	576p	50	31.250	27.000	x	x	x	ITU-R BT.1358, CEA-861-F Format 17 & 18

Compatible Video Sources								
Signal Type	Resolution	Frame Rate (Hz)	Line Rate (kHz)	Pixel Rate (MHz)	HDMI + OPS	DisplayPort	VGA	References
HDTV	1080i	50	28.125	74.500	x	x	x	SMPTE 274M, CEA-861-F Format 20
	1080i	60	33.750	74.250	x	x	x	SMPTE 274M, CEA-861-F Format 5
	720p	50	37.500	74.250	x	x	x	SMPTE 296M, CEA-861-F Format 19
	720p	60	45.000	74.250	x	x	x	SMPTE 296M, CEA-861-F Format 4
	1080p	24	27.000	74.250	x	x	x	SMPTE 274M, CEA-861-F Format 32
	1080p	25	28.125	74.250	x	x	x	SMPTE 274M, CEA-861-F Format 33
	1080p	30	33.750	74.250	x	x	x	SMPTE 274M, CEA-861-F Format 34
	1080p	50	56.250	148.500	x	x	x	SMPTE 274M, CEA-861-F Format 31
	1080p	60	67.500	148.500	x	x	x	SMPTE 274M, CEA-861-F Format 16
	1080p	60	67.500	148.500	x	x	x	SMPTE 274M, CEA-861-F Format 16
UHDTV	3840x2160	24	54.000	297.000	x	x		CEA-861-F Format 93, HDMI 1.4b VIC 1
	3840x2160	25	56.250	297.000	x	x		CEA-861-F Format 94, HDMI 1.4b VIC 2
	3840x2160	30	67.500	297.000	x	x		CEA-861-F Format 95, HDMI 1.4b VIC 3
	3840x2160	50	56.250	297.000	x			CEA-861-F Format 96, 4:2:0 sub-sampling
	3840x2160	50	112.500	594.000	x	x		CEA-861-F Format 96
	3840x2160	60	67.500	297.000	x			CEA-861-F Format 97, 4:2:0 sub-sampling
	3840x2160	60	135.000	594.000	x	x		CEA-861-F Format 97
	4096x2160	24	54.000	297.000	x	x		CEA-861-F Format 98
	4096x2160	25	56.250	297.000	x	x		CEA-861-F Format 99
	4096x2160	30	67.500	297.000	x	x		CEA-861-F Format 100

# Color Subsampling Support

Video Timing	Input	RGB 4:4:4 Supported	YUV 4:4:4 Supported	YUV 4:2:2 Supported	YUV 4:2:0 Supported
4K @ 50/60Hz	HDMI 1-2, OPS	x	x	x	x
4K @ 50/60Hz	DisplayPort	x	x	x	
All Other Supported Timings	All Inputs	x	x	x	

# Power Consumption

The power consumption values stated in the Specifications table are calculated under the typical conditions of viewing a single source with default settings.

Due to the advanced capabilities of the Planar VM Series, and the widely variable power consumption of user-installed OPS devices, the total maximum power draw of Planar VM Series is influenced by several factors:

- The use of Local Dimming and backlight variables that occur as content changes
- The variable power consumption of an installed OPS device

Given the relatively low likelihood of all the above conditions being met and maximized simultaneously, the “Power Consumption: Backlight Max (Typ.)” value is instead calculated by increasing the default backlight value of 70 to 100, and multiplying the wattage by approximately 1.43. The power consumption would increase above these specified values if the above factors are introduced, and should be taken into account when estimating power consumption.



# Specifications

Item	VM55LX-M2	VM55LX-U2	VM55LX-X2	VM55MX-M2	VM55MX-X2
<b>LCD Panel</b>					
Display Technology	Commercial-Grade IPS LCD				
Resolution	1920x1080				
Aspect Ratio	16:9				
Screen Size	55"				
Orientation	Landscape / Portrait				
Brightness (Typ.)	500 cd/m <sup>2</sup>			700 cd/m <sup>2</sup>	
Contrast Ratio (Typ.; local dimming enabled)	100,000:1	20,000:1	100,000:1	140,000:1	
Contrast Ratio (Typ.; local dimming disabled)	1100:1	1200:1	1000:1	1100:1	1000:1
Viewing Angle (Typ.)	178 degrees				
Response Time (Typ.)	8ms				
Color Gamut	72% NTSC				
Display Color	1.07 billion (10-bit depth)				
Haze (Typ.)	28%	28%	28%	28%	28%
<b>Connectivity</b>					
Standard Inputs	HDMI 2.0 x 2, DisplayPort 1.2, VGA, OPS				
HDCP 2.2	Yes (HDMI, OPS)				
Audio Output	Line out, S/PDIF out				
Control and Monitoring	LAN RJ45, RS232 In/Out, IR In/Out, HDMI-CEC, Keypad				
<b>Mechanical</b>					
Display Dimensions w/ Handles	47.7" x 26.8" x 4.0" (1210.5mm x 681.2mm x 101.8mm)	47.8" x 26.9" x 4.0" (1213.4mm x 684.2mm x 102.7mm)	47.7" x 26.9" x 4.0" (1212.2mm x 683.0mm x 102.2mm)	47.7" x 26.8" x 4.0" (1210.5mm x 681.2mm x 101.8mm)	47.7" x 26.9" x 4.0" (1212.2mm x 683.0mm x 102.2mm)

Item	VM55LX-M2	VM55LX-U2	VM55LX-X2	VM55MX-M2	VM55MX-X2
Display Dimensions w/o Handles	47.7" x 26.8" x 3.8" (1210.5mm x 681.2mm x 97.1mm)	47.8" x 26.9" x 3.9" (1213.4mm x 684.2mm x 98.0mm)	47.7" x 26.9" x 3.8" (1212.2mm x 683.0mm x 97.5mm)	47.7" x 26.8" x 3.8" (1210.5mm x 681.2mm x 97.1mm)	47.7" x 26.9" x 3.8" (1212.2mm x 683.0mm x 97.5mm)
Bezel Width	0.44mm even	2.3mm (left / top), 1.2mm (right / bottom)	1.7mm (left / top), 0.9mm (right / bottom)	0.44mm even	1.7mm (left / top), 0.9mm (right / bottom)
Tiled Bezel Width	0.88mm	3.5mm	2.6mm	0.88mm	2.6mm
Display Weight	52 lbs (23 kg)	58 lbs (26 kg)	55 lbs (25 kg)	52 lbs (23 kg)	55 lbs (25 kg)
Mounting	VESA 400x400				
Fanless	Yes				
Speakers	10W x 2 built-in				
<b>Usage</b>					
Recommended Usage	24x7				
Backlight	D-LED with Local Dimming				
Backlight Life	50,000 hours min		100,000 hours min	50,000 hours min	100,000 hours min
<b>Power Source</b>					
Power Consumption (Typ.)	130W	75W	95W	115W	115W
Power Consumption Backlight Max (Typ.)*	185W	105W	135W	165W	165W
BTU/hr (Typ.)	130W x 3.42 BTU = 445 BTU/hr	75W x 3.42 BTU = 257 BTU/hr	95W x 3.42 BTU = 325 BTU/hr	115W x 3.42 BTU = 393 BTU/hr	115W x 3.42 BTU = 393 BTU/hr
Standby Power Consumption	< 0.5W				
Input Voltage / Frequency	AC 100-240V 50-60 Hz				
AC Inlet Type	C14				
OPS Power	16V / 4A				

\* Refer to the "Power Consumption" section on page 64 for details on how this is calculated.

Item	VM55LX-M2	VM55LX-U2	VM55LX-X2	VM55MX-M2	VM55MX-X2
<b>Environment</b>					
Storage Temperature	Min -4°F ~ Max 140°F (-20°C ~ 60°C)				
Operating Temperature	Min 32°F ~ Max 104°F (0-40°C) at up to 3000 m				
Humidity	20-85% RH				
Approvals	FCC Class A, cTUVus, CE				
ENERGY STAR Certified	No	Yes			

# Dimensions

## VM55LX-M2 and VM55MX-M2

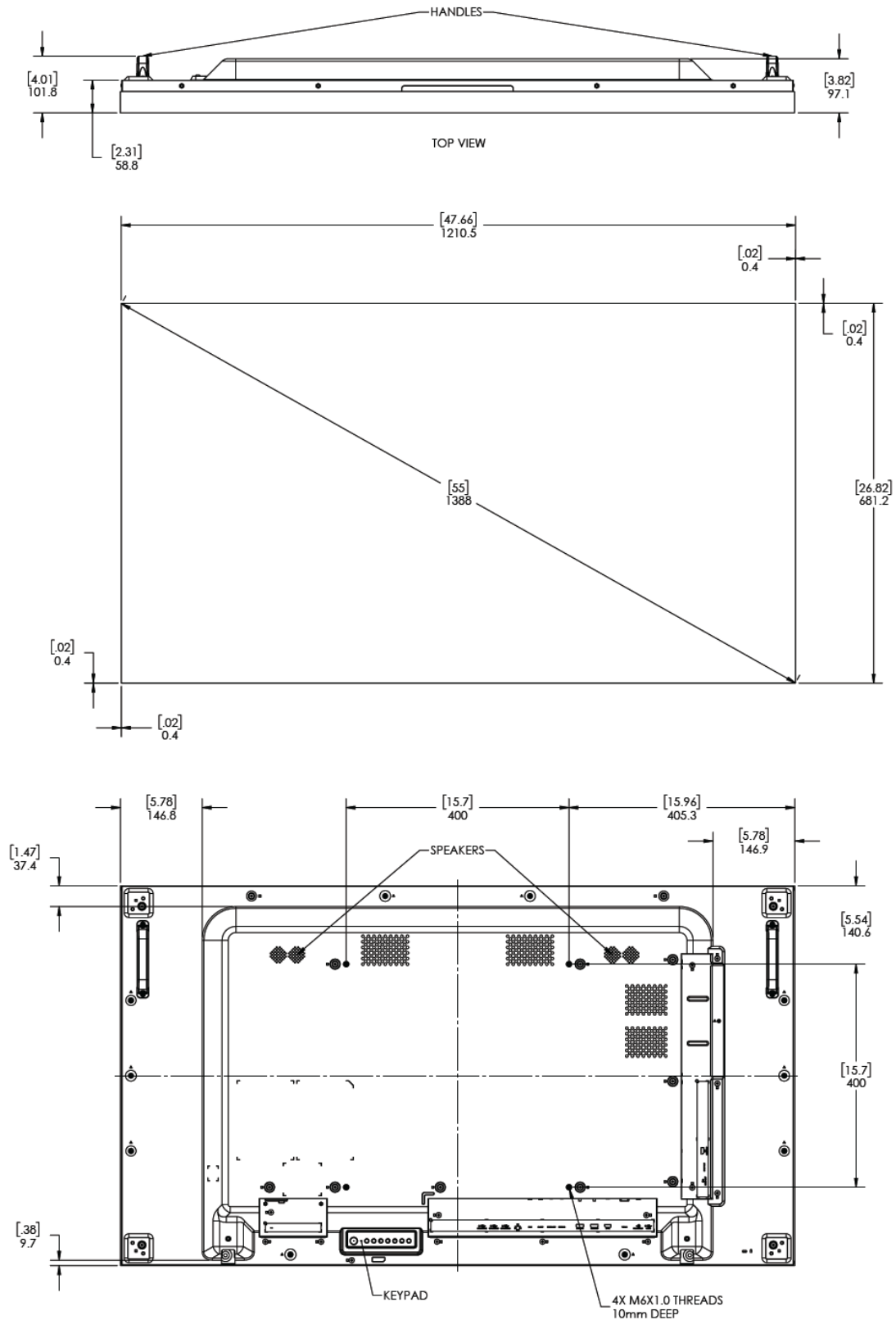

# VM55LX-X2 and VM55MX-X2

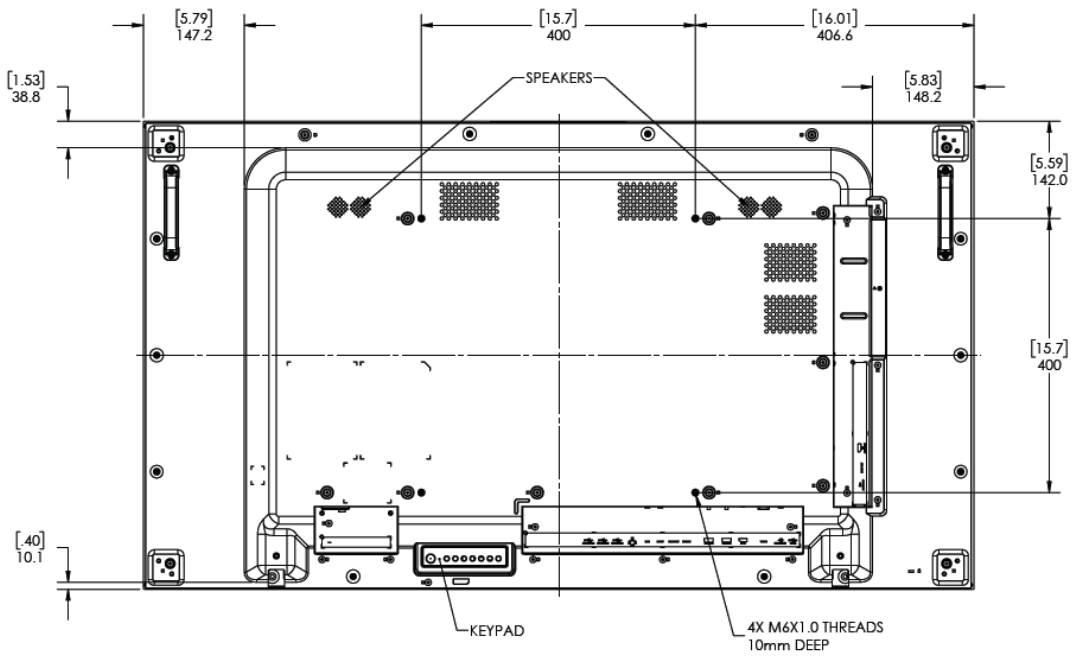
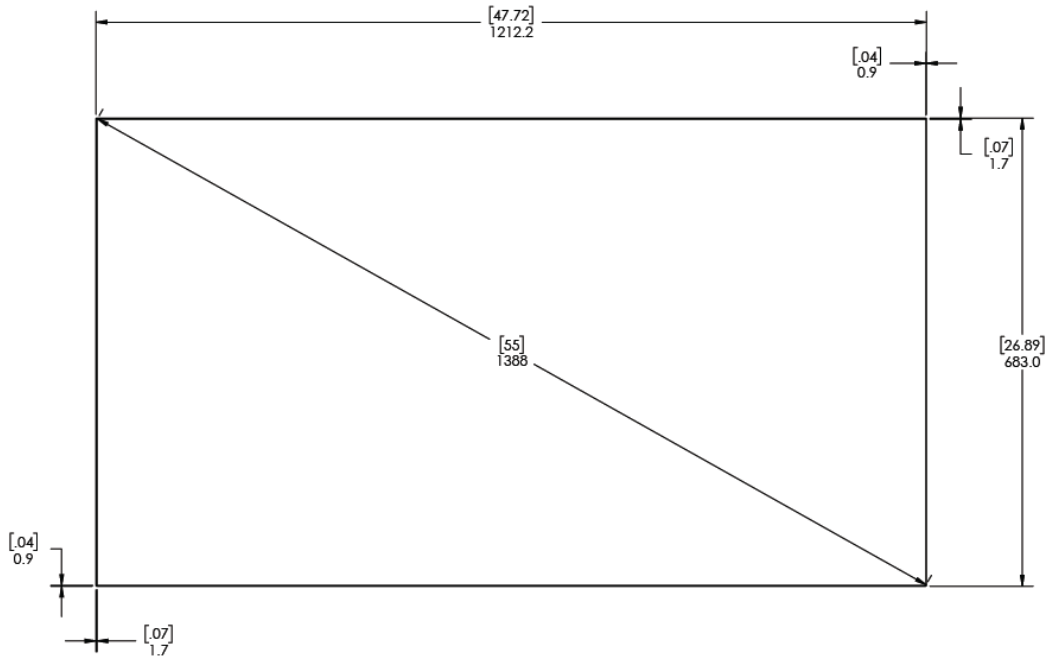
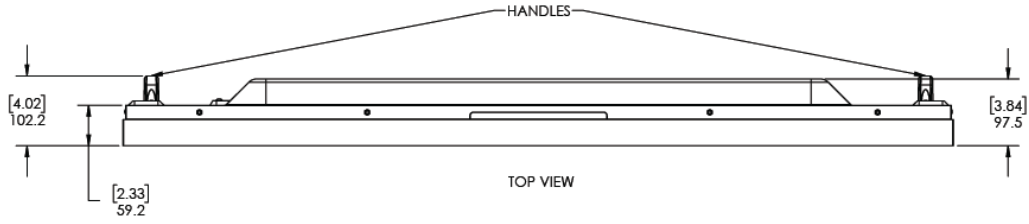

# Troubleshooting

Before calling service personnel, please check the following table for a possible cause of the problem you are experiencing. Please note the following:

- Perform the adjustments according to "Operating the Display" on page 28.
- If the problem you are experiencing is not described below, or you cannot correct the problem, stop using the display and contact Planar's Technical Support Department. See "Accessing the Planar Technical Support Website" on page 71.

Issue	Check for the following
No image is displayed	Make sure the correct source is selected.
	Make sure the main power switch is ON.
	Check that the source equipment is operating correctly.
	Make sure the input signal is compatible with this display.
The image is not centered	Make sure the input signal is compatible with this display.
The remote control doesn't work	Make sure the batteries are new and installed correctly. Ensure the remote is aimed at the IR sensor.
	Make sure the remote control sensor is plugged in correctly.
	Make sure the remote is aimed towards the back of the display where the sensor is located.
The picture color looks poor	Check the picture settings. Reset the display

# Accessing the Planar Technical Support Website

Go to <http://www.planar.com/support/> to locate the following support documents and resources:

- User Guide
- RS232 User Manual
- Standard Warranties
- Planar support hotline number and email

# Index

## A

adjusting volume, 33  
 advanced option menu, 48  
 audio menu, 40

## B

batteries, 17  
 burn-in, 8

## C

cable clips, 18  
 cable lengths, 21  
 cleaning the display, 14  
 color subsampling, 63  
 configuration 1 menu, 42  
 configuration 2 menu, 45  
 cooling requirements, 9  
 cosmetic trim, 27

## D

default  
 Picture reset, 37  
 display  
 cleaning, 14  
 handling, 23  
 operating, 28  
 turning on / off, 33  
 unpacking, 22

## E

external control, 60

## F

factory reset, 44

## H

handling, 23  
 HDMI  
 Installing the Display, 21

## I

inputs, 19  
 installation  
 cable clips, 18  
 cosmetic trim, 27  
 location, 21  
 mounts, 11  
 of display on a wall, 20  
 OPS, 26  
 planning, 20  
 IR remote key codes, 31

## L

LED indicators, 29

## M

menus  
 advanced option, 48  
 audio, 40  
 configuration 1, 42  
 configuration 2, 45  
 navigating, 33  
 picture, 34  
 screen, 38  
 mounts, 11

## N

navigating menus, 33  
 normal usage guidelines, 9

## O

OPS, 26  
 OSD keypad, 28  
 OSD main menu, 34, 55

## P

package contents, 15  
 picture menu, 34

## R

remote control  
 pairing to the display, 32  
 using, 31

## S

safety, 6  
 screen menu, 38  
 service plans, 2  
 signal compatibility, 61  
 source, 33

## T

temporary image retention, 8  
 trim, 27  
 troubleshooting, 70  
 turning on / off, 33

## U

unpacking, 22



## V

VESA mounts, 11  
volume, 33

## W

warranty, 2, 8  
waste disposal, 9