

Planar[®] ContentSmart[™] Software Training





ContentSmart over-view, 4 easy steps:



Video



Photos

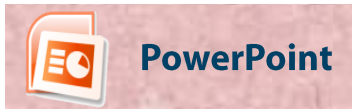

PowerPoint



Music

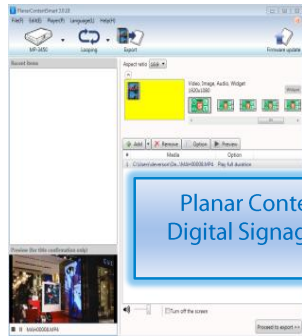

Planar ContentSmart™
Digital Signage Software



via Network



via USB



Install ContentSmart Software on Your PC

1

Insert CD into your PC,
and follow the instructions



2

After completion,
this icon will be on your desktop



3

Double click it to start ContentSmart

Note: If you are using Windows XP (not Vista), and did not install Microsoft .NET software before, it will take a few more minutes to install .NET onto your PC.
User Manuals are on the CD as well .

Welcome & Instructions

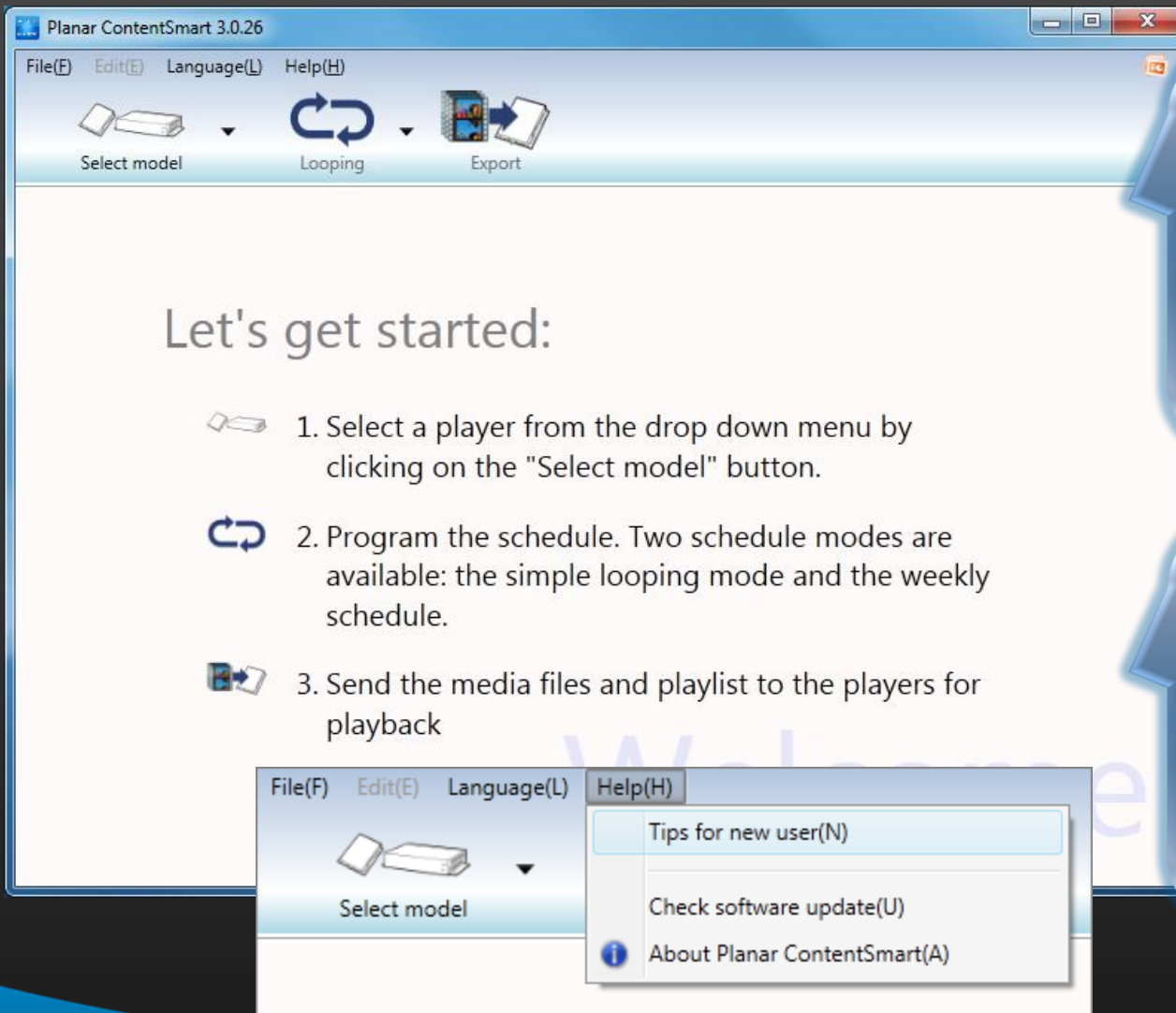

Planar ContentSmart 3.0.26

File(F) Edit(E) Language(L) Help(H)

Select model Looping Export

Let's get started:

1. Select a player from the drop down menu by clicking on the "Select model" button.
2. Program the schedule. Two schedule modes are available: the simple looping mode and the weekly schedule.
3. Send the media files and playlist to the players for playback

File(F) Edit(E) Language(L) Help(H)

Select model

- Tips for new user(N)
- Check software update(U)
- About Planar ContentSmart(A)

Tips for new user will appear when launching software for the first time.

The message can also be accessed from menu bar: Help > Tips for new user.

Develop Playlist and Export

Firmware Update

1

Select Player

Design and Publish Playlist in 4 Simple Steps

2

Choose Template

3

Add Assets to Playlist

4

Export to Player

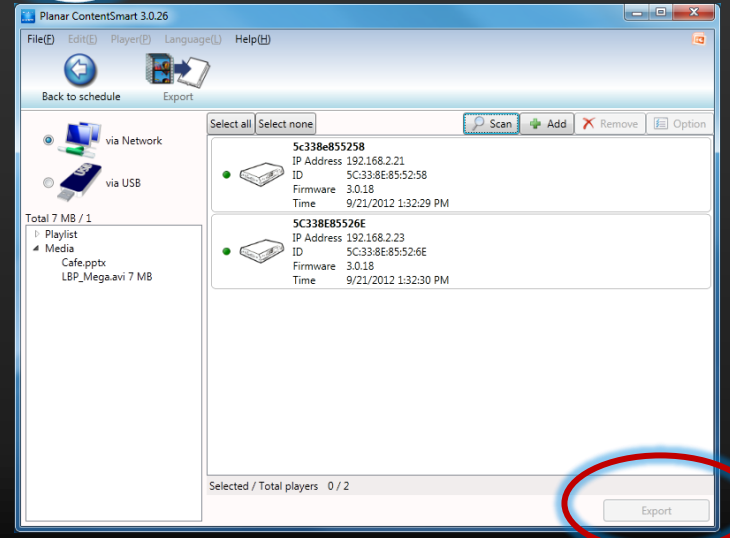
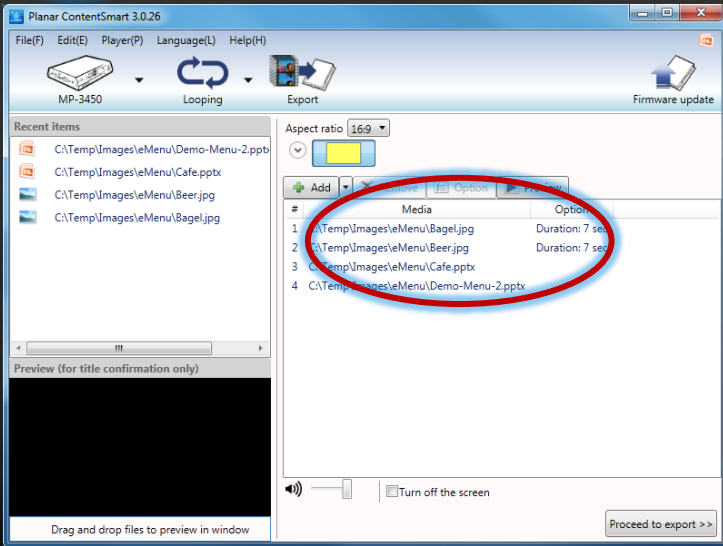
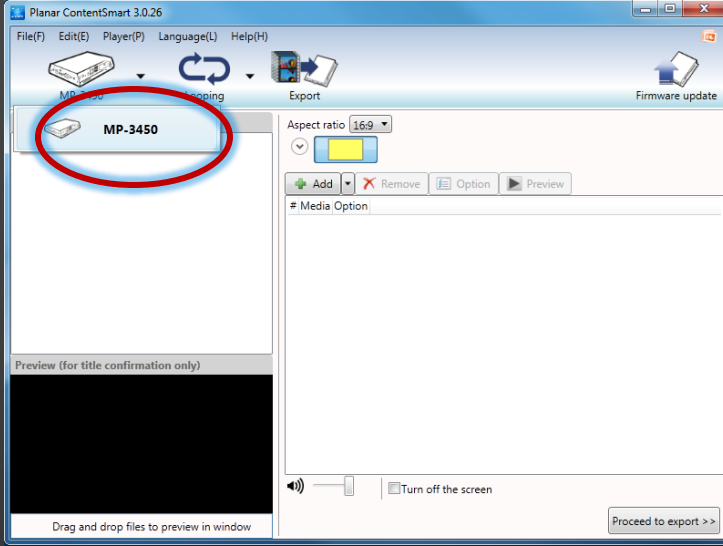

1

Select Player

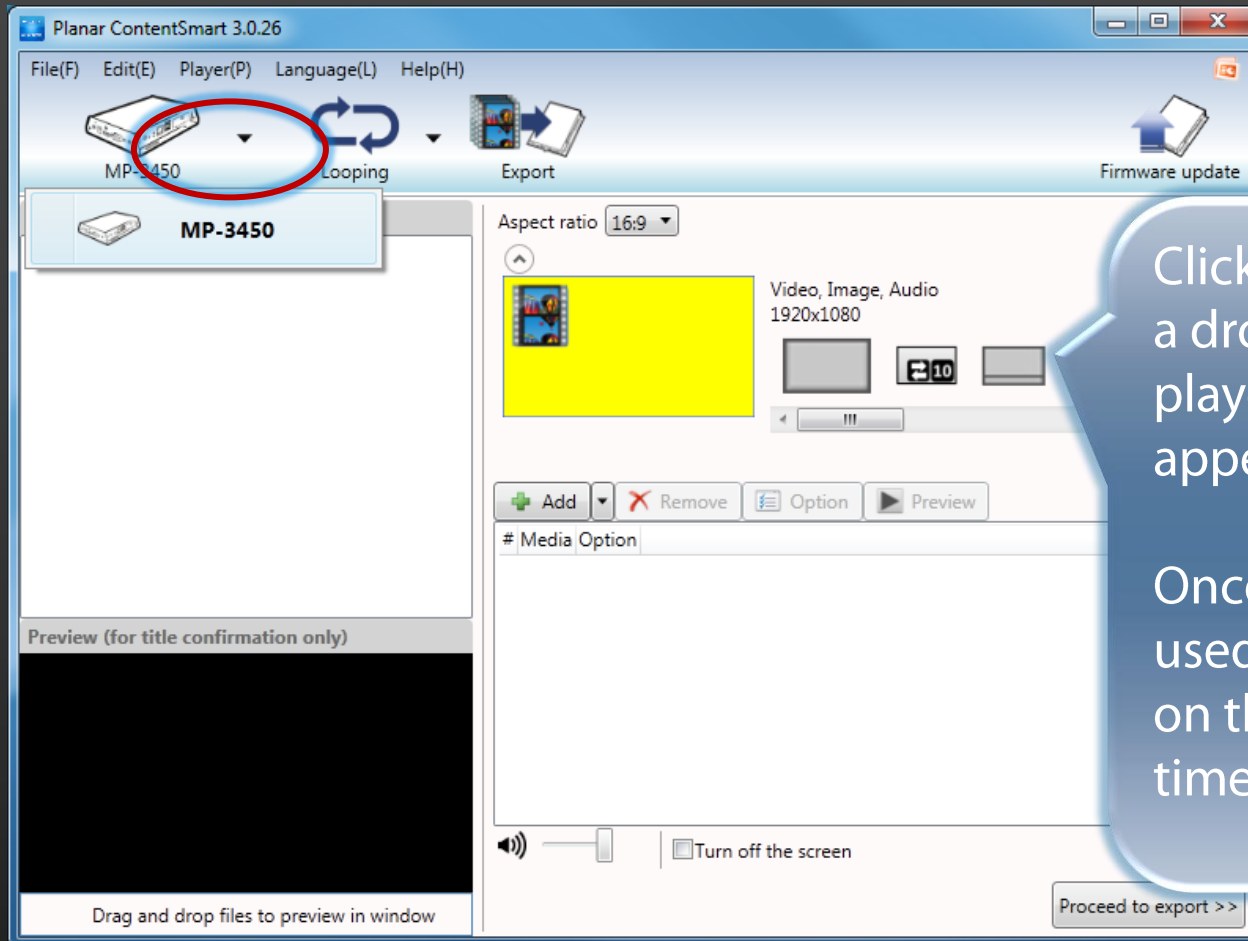

Click **model arrow**, a drop down player menu will appear.

Once a model is used, it will appear on the list next time.

2

Choose which template you want

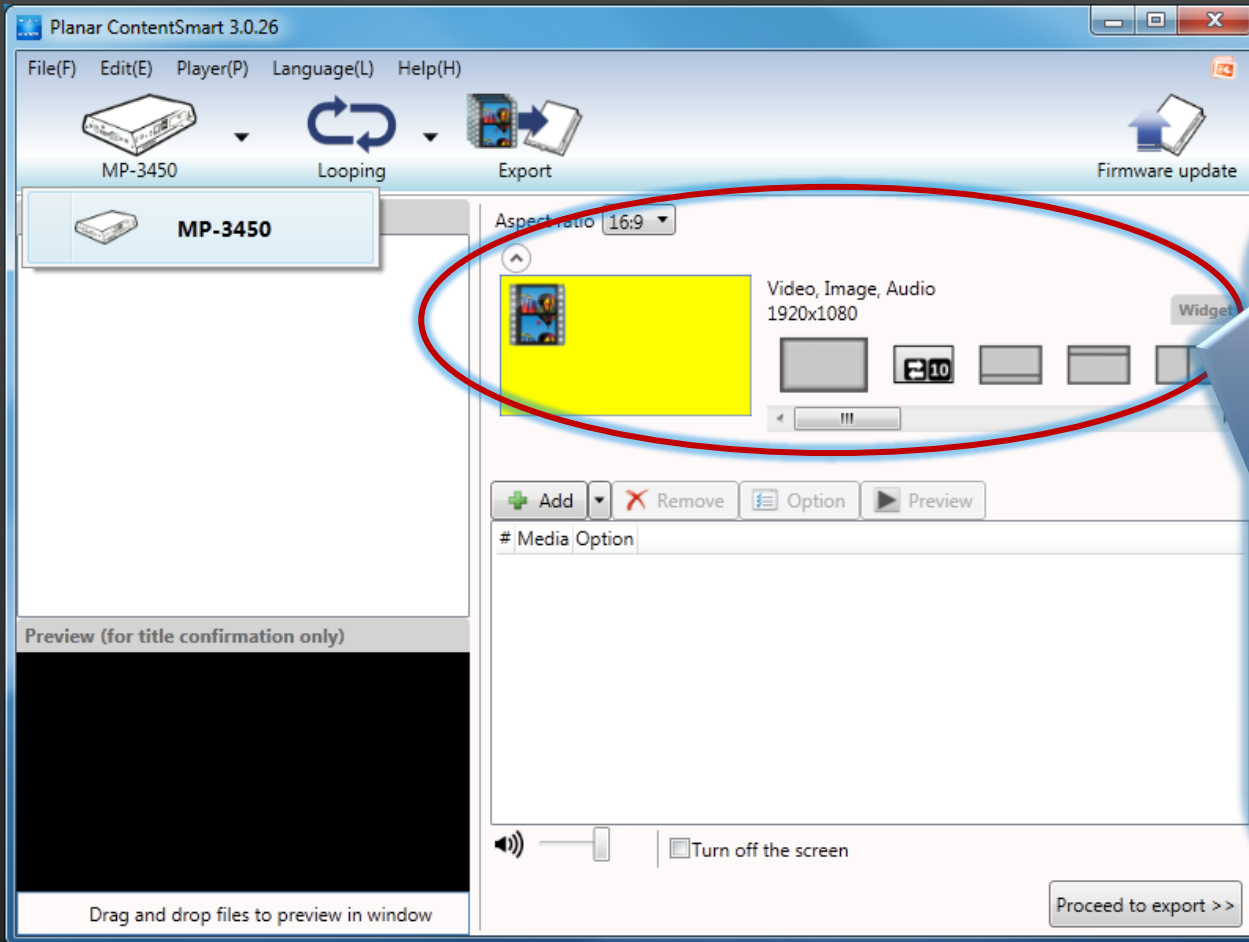

Click/highlight one of the **templates**:
13 standard templates or 7 Smart Widget templates.

3

Import files from your PC onto template playlist

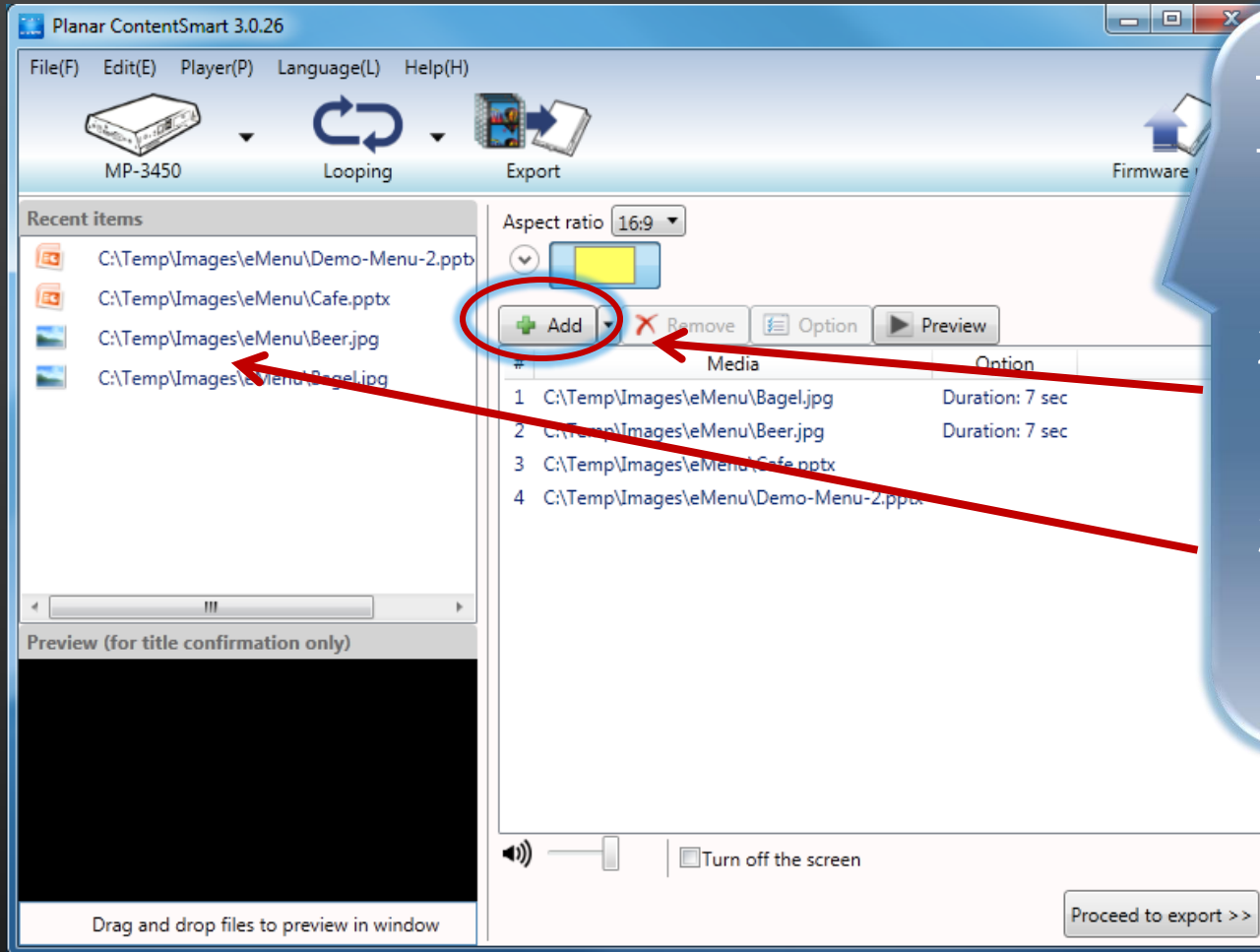

- Three ways to add files to playlist:
1. Click **Add** button.
 2. Drag & drop file from File Explorer.
 3. Add from **Recent items** listing.

3

Select Files from Usage History (Recent items)

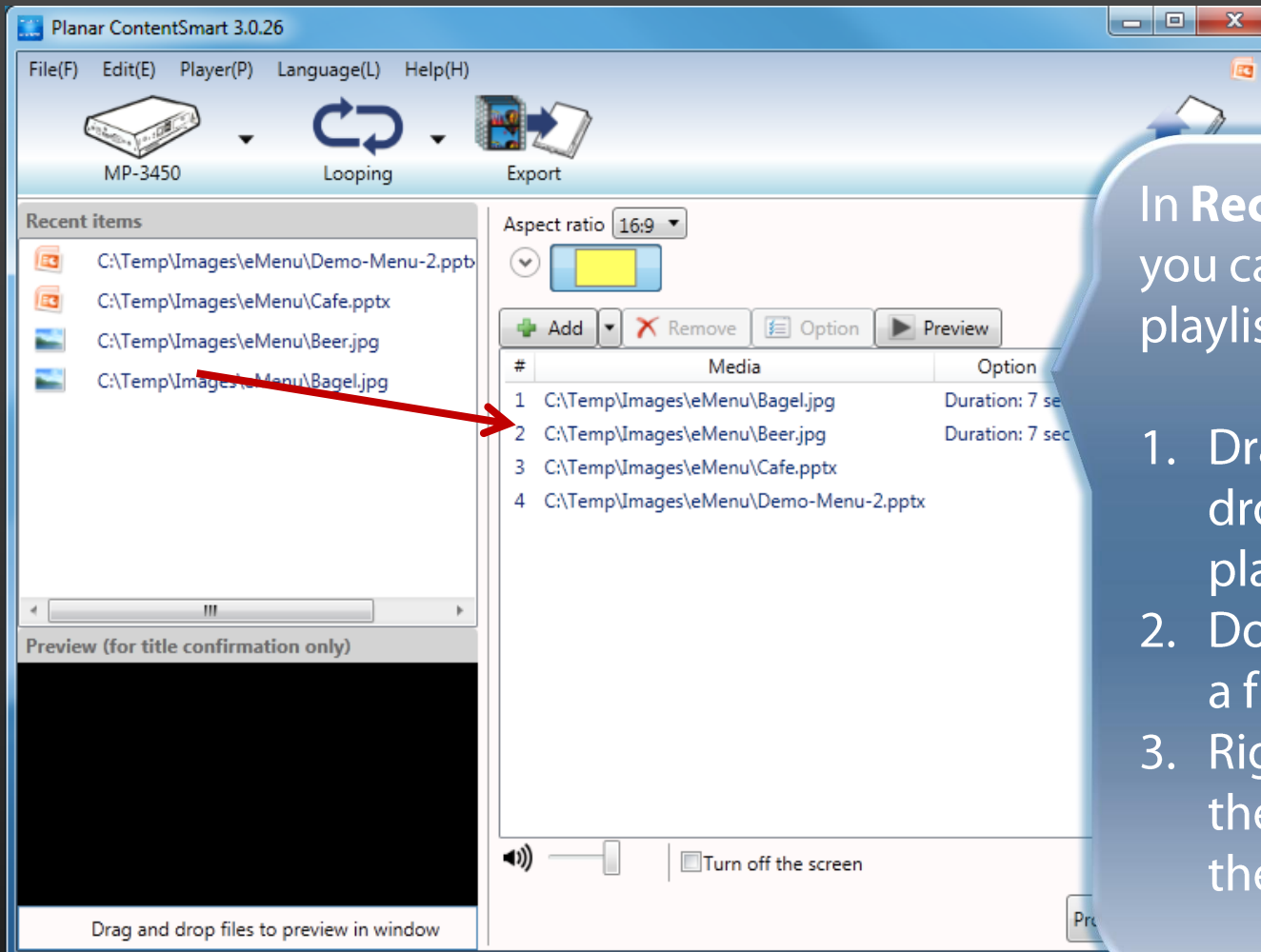

In Recent items box, you can add files to playlist by

1. Dragging a file & dropping it to playlist.
2. Double clicking on a file.
3. Right clicking on the selected files then choose "Add".

Support PowerPoint Slide Show

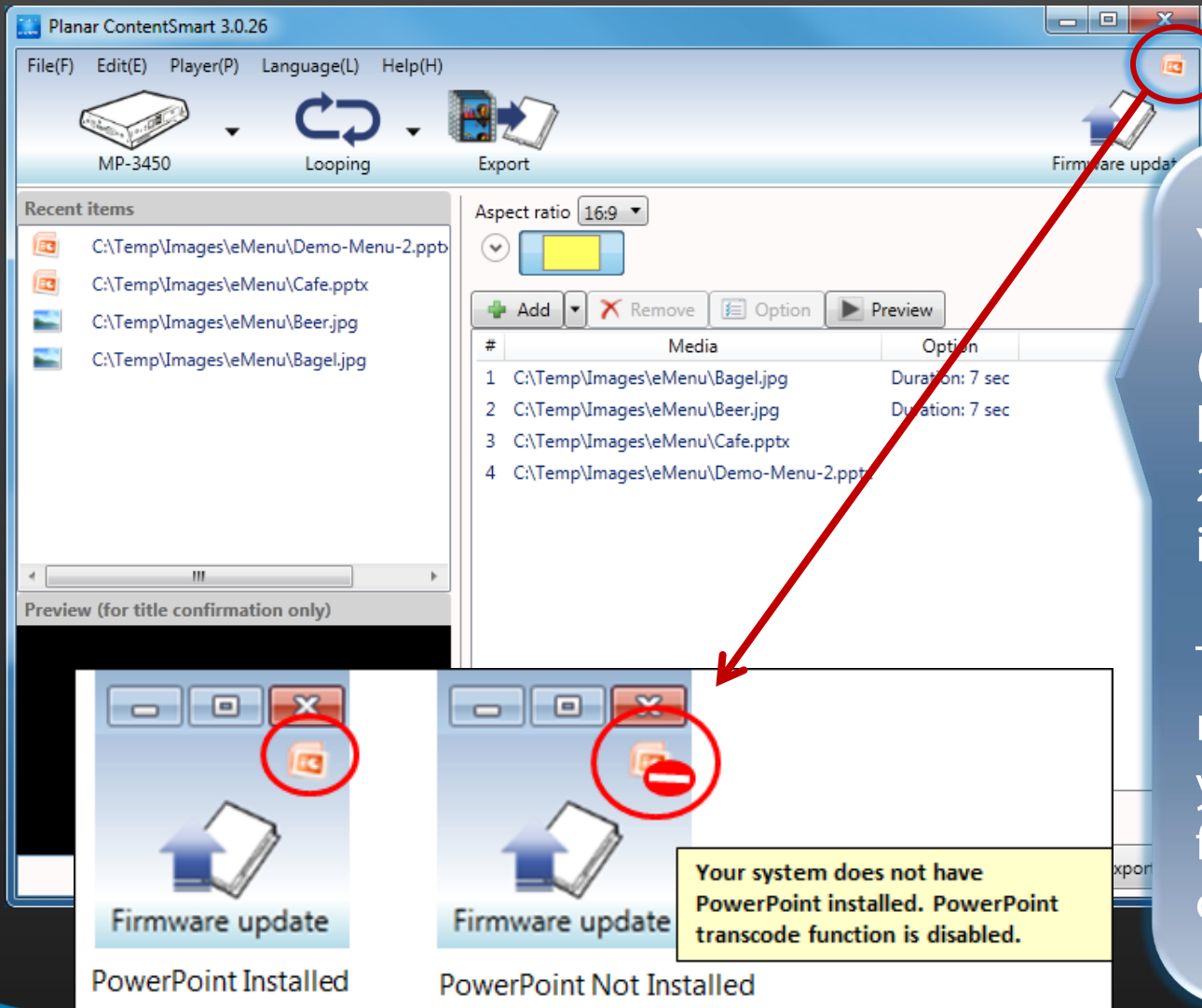

Planar ContentSmart 3.0.26

File(F) Edit(E) Player(P) Language(L) Help(H)

MP-3450 Looping Export Firmware update

Recent items

- C:\Temp\Images\eMenu\Demo-Menu-2.pptb
- C:\Temp\Images\eMenu\Cafe.pptx
- C:\Temp\Images\eMenu\Beer.jpg
- C:\Temp\Images\eMenu\Bagel.jpg

Aspect ratio 16:9

Add Remove Option Preview

#	Media	Option
1	C:\Temp\Images\eMenu\Bagel.jpg	Duration: 7 sec
2	C:\Temp\Images\eMenu\Beer.jpg	Duration: 7 sec
3	C:\Temp\Images\eMenu\Cafe.pptx	
4	C:\Temp\Images\eMenu\Demo-Menu-2.pptb	

Preview (for title confirmation only)

PowerPoint Installed

PowerPoint Not Installed

Your system does not have PowerPoint installed. PowerPoint transcode function is disabled.

You can export PowerPoint slides (in static only) if you have PowerPoint 2003/2007/2010 installed on your PC.

The red icon in top-right indicates if your PowerPoint feature is enabled or not.

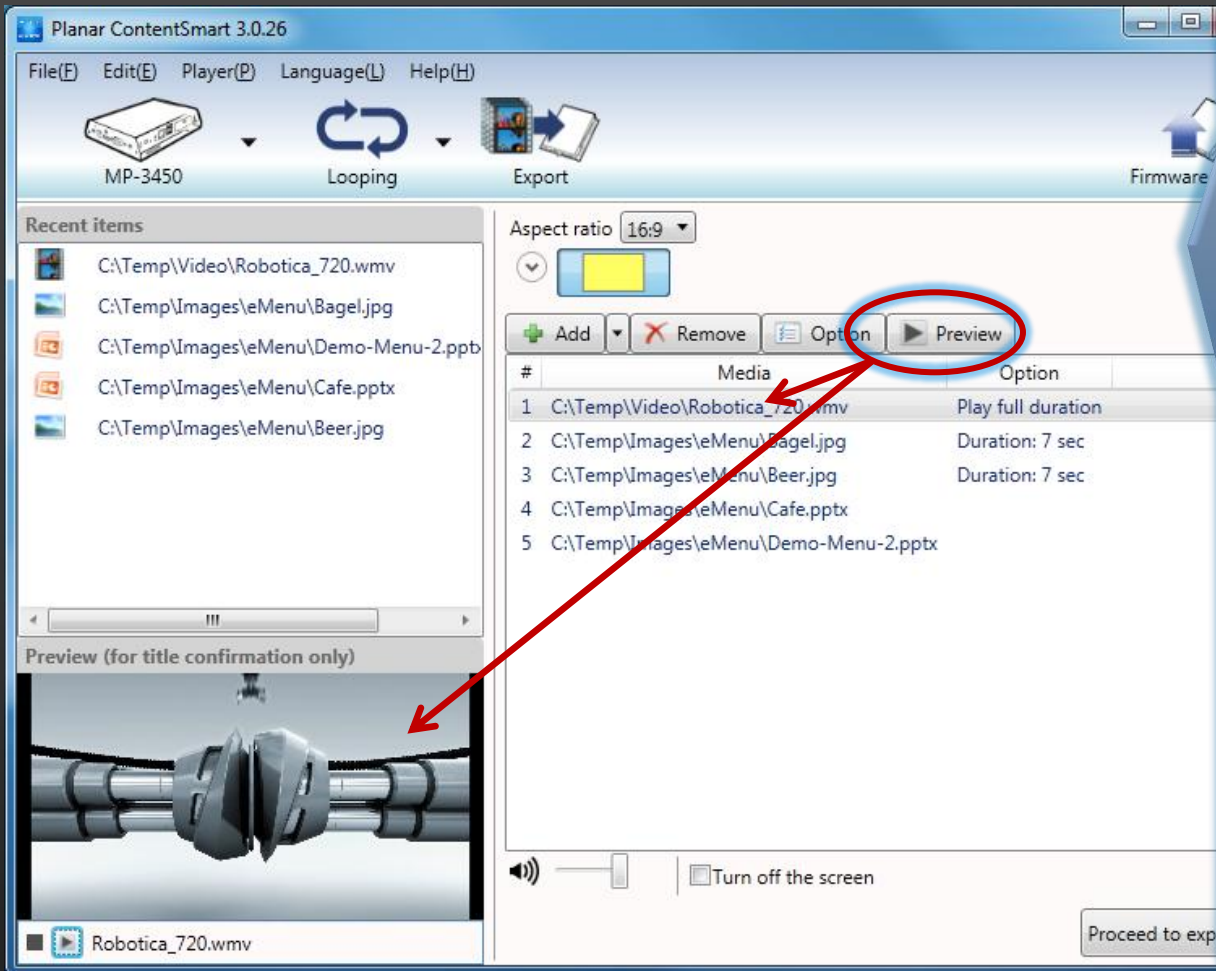

Embedded Microsoft Windows Media Player can be used to preview content.

NOTE: This function is for file viewing purpose only. It does not represent what can or cannot be played on the media player.

Planar ContentSmart 3.0.26

File(F) Edit(E) Player(P) Language(L) Help(H)

MP-3450 Looping Export Firmware

Recent items

- C:\Temp\Video\Andrew...\CN13_1.mp3
- C:\Temp\Video\Robotica_720.wmv
- C:\Temp\Images\Menu\Bagel.jpg
- C:\Temp\Images\Menu\Demo-Menu-2.pptx
- C:\Temp\Images\Menu\Cafe.pptx
- C:\Temp\Images\Menu\Beer.jpg

Aspect ratio 16:9

+ Add - Remove Option Preview

#	Media	Option
1	C:\Temp\Video\Robotica_720.wmv	Play full duration
2	C:\Temp\Video\Andrew...\CN13_1.mp3	Play full duration
3	C:\Temp\Images\Menu\Bagel.jpg	Duration: 7 sec
4	C:\Temp\Images\Menu\Cafe.pptx	
5	C:\Temp\Images\Menu\Demo-Menu-2.pptx	
6	C:\Temp\Images\Menu\Beer.jpg	Duration: 7 sec

Preview (for title confirmation only)

Robotica_720.wmv

Option

Image

Duration 7

Fill zone exactly (does not keep aspect ratio)

Video

Play full duration

Duration

Fit inside zone (keep aspect ratio)

Audio

Play full duration

Duration

PowerPoint

Unspecified slide duration 7

Fill zone exactly (does not keep aspect ratio)

OK Cancel

You can highlight and change options for each media item.

Default settings:

- **Video:** play full length
- **Image :** 7 seconds
- **Audio:** play full duration
- **PowerPoint:** If "slide interval" is not set in PowerPoint then play slide for 7 seconds.

Schedule Video On/Off

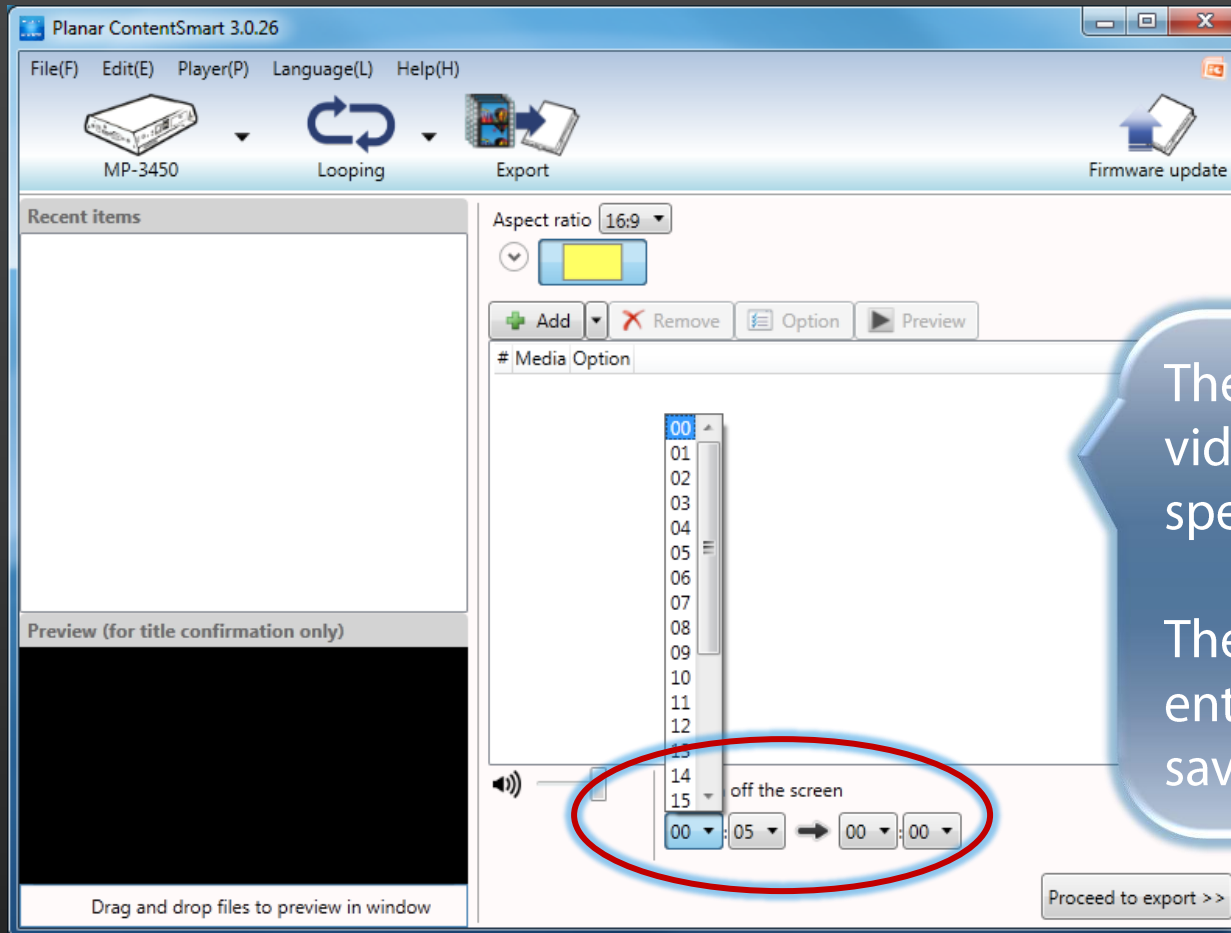

The player can stop video output at a specific time.

The screen will enter sleep mode to save power.

Adjust Player Volume

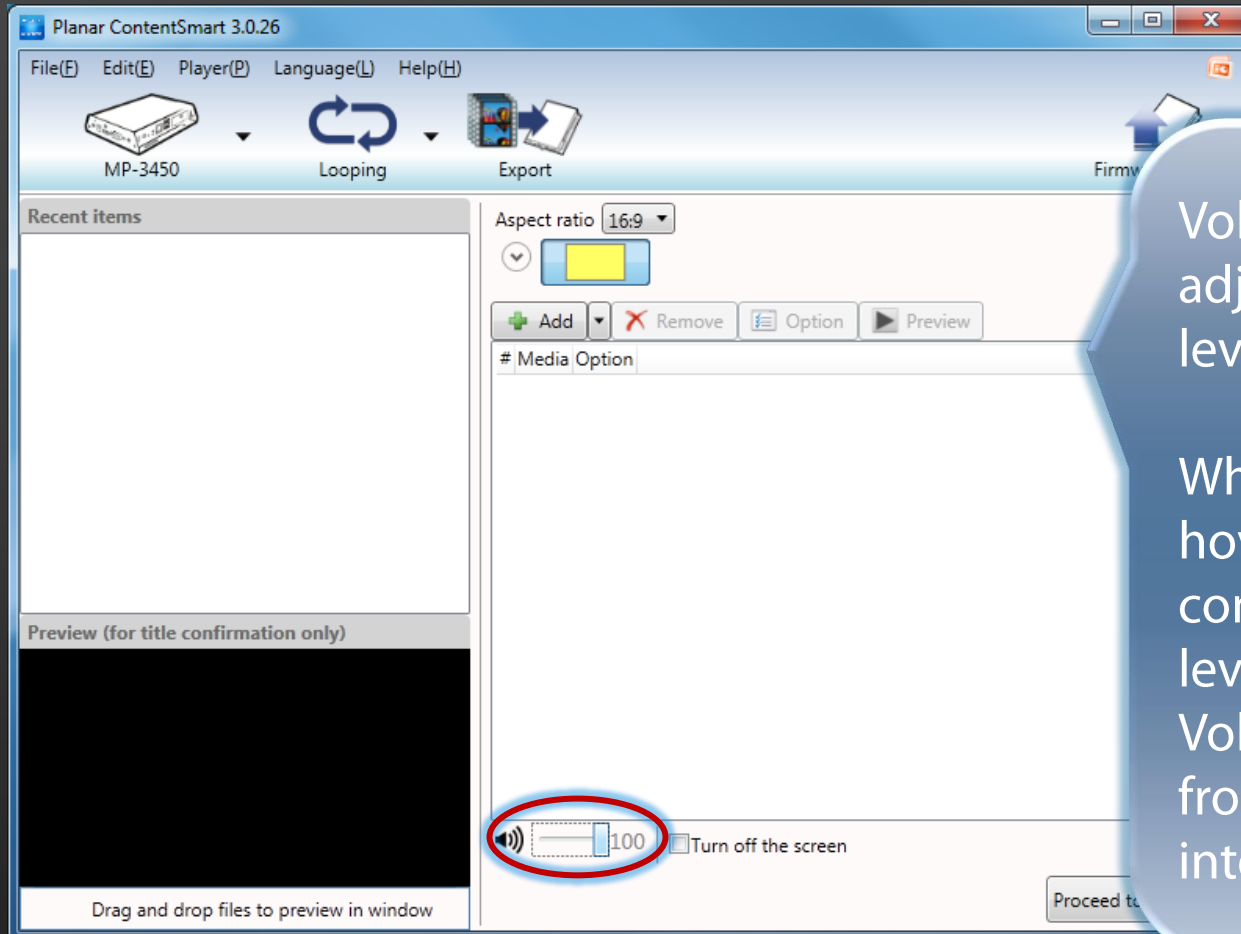

Volume can be adjusted at playlist level.

When mouse cursor hovers over volume control, the volume level will appear. Volume level ranges from 0 to 100 at interval of 10.

Looping Schedule

The screenshot displays the Planar ContentSmart 3.0.26 software interface. The 'Looping' option in the menu is circled in red. The main window shows a list of recent items and a media playlist table. A preview window at the bottom shows a 3D rendering of a mechanical part.

#	Media	Option
1	C:\Temp\Video\Robotica_720.wmv	Play full duration
2	C:\Temp\Images\eMenu\Bagel.jpg	Duration: 7 sec
3	C:\Temp\Images\eMenu\Beer.jpg	Duration: 7 sec
4	C:\Temp\Images\eMenu\Cafe.pptx	
5	C:\Temp\Images\eMenu\Demo-Menu-2.pptx	

Preview (for title confirmation only)

Robotica_720.wmv

MP-3450

Looping

Export

Aspect ratio 16:9

File(F) Edit(E) Player(P) Language(L) Help(H)

Looping

Weekly schedule

Looping schedule will simply play the files repeatedly (until you turn off the screen).

Weekly schedule mode can also be accessed from menu:
Edit > Weekly schedule.

3

Weekly Schedule

The screenshot shows the Planar ContentSmart 3.0.26 software interface. The menu bar includes File(F), Edit(E), Player(P), Language(L), and Help(H). The toolbar contains icons for MP-3450, Weekly schedule (circled in red), Export, and Firmware update. The main window is divided into two sections: 'Schedule template' on the left and a grid on the right. The 'Schedule template' section lists four categories: Bakery, FastFood, Food Court, and Shopping Mall, each with a description and opening hours. The grid on the right shows a weekly schedule for a 16:9 aspect ratio, with columns for SUN, MON, TUE, WED, THU, FRI, and SAT, and rows for time slots from 00:00 to 12:00. A red arrow points from the 'FastFood' template to the 05:00 slot on Sunday. A 'Proceed to export >>' button is located at the bottom right of the grid.

	SUN	MON	TUE	WED	THU	FRI	SAT
00:00	OFF	OFF					OFF
01:00	SUN 00:00 → 10:00	MON → FRI 00:00 → 09:00					SAT 00:00 → 10:00
02:00							
03:00							
04:00							
05:00							
06:00							
07:00							
08:00							
09:00							
10:00		MON → FRI 09:00 → 19:00					
11:00	SUN 10:00 → 20:00						SAT 10:00 → 20:00
12:00							

Create your schedule or drag a preset template on the left to the right-box.

Update the schedule every week.

Create Your Own Weekly Schedule

The screenshot shows the Planar ContentSmart 3.0.26 software interface. The main window displays a weekly schedule template with a calendar grid. The left sidebar lists content categories: Bakery, FastFood, Food Court, and Shopping Mall. The calendar grid shows a pink highlighted time slot from 03:00 to 11:00 on SUN to FRI. A red circle highlights the 'Add' button in the top left of the calendar grid. A red arrow points from this button to a callout box. Another red arrow points from the 'Edit' button in a context menu to a second callout box. The context menu also shows 'Remove' and 'Screen off' options. The 'Edit' dialog box is open, showing time selection (03:00 to 11:00) and day selection (SUN to FRI).

Click & drag on the calendar or click **Add** button to create time slot.

Right click on time slot and choose **Edit** to configure and add files to each time slot's playlist.

4

Switch to Export Mode

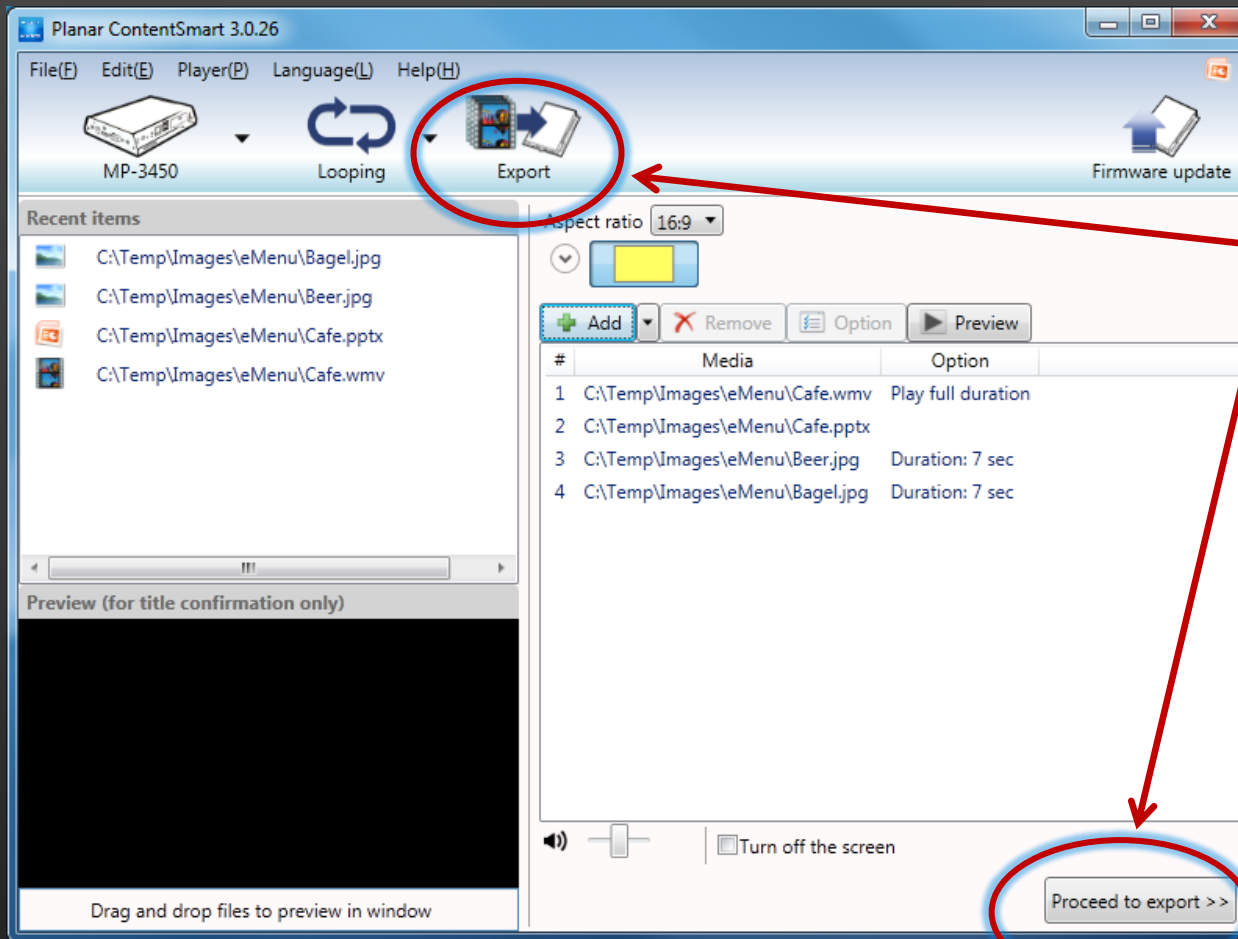

Click **Export** on top or bottom to switch to Export mode.

4

Export to the Player

Back to previous steps.

Auto detect all players in your LAN network.

Password protected player on the network.

Click **Export** and done!

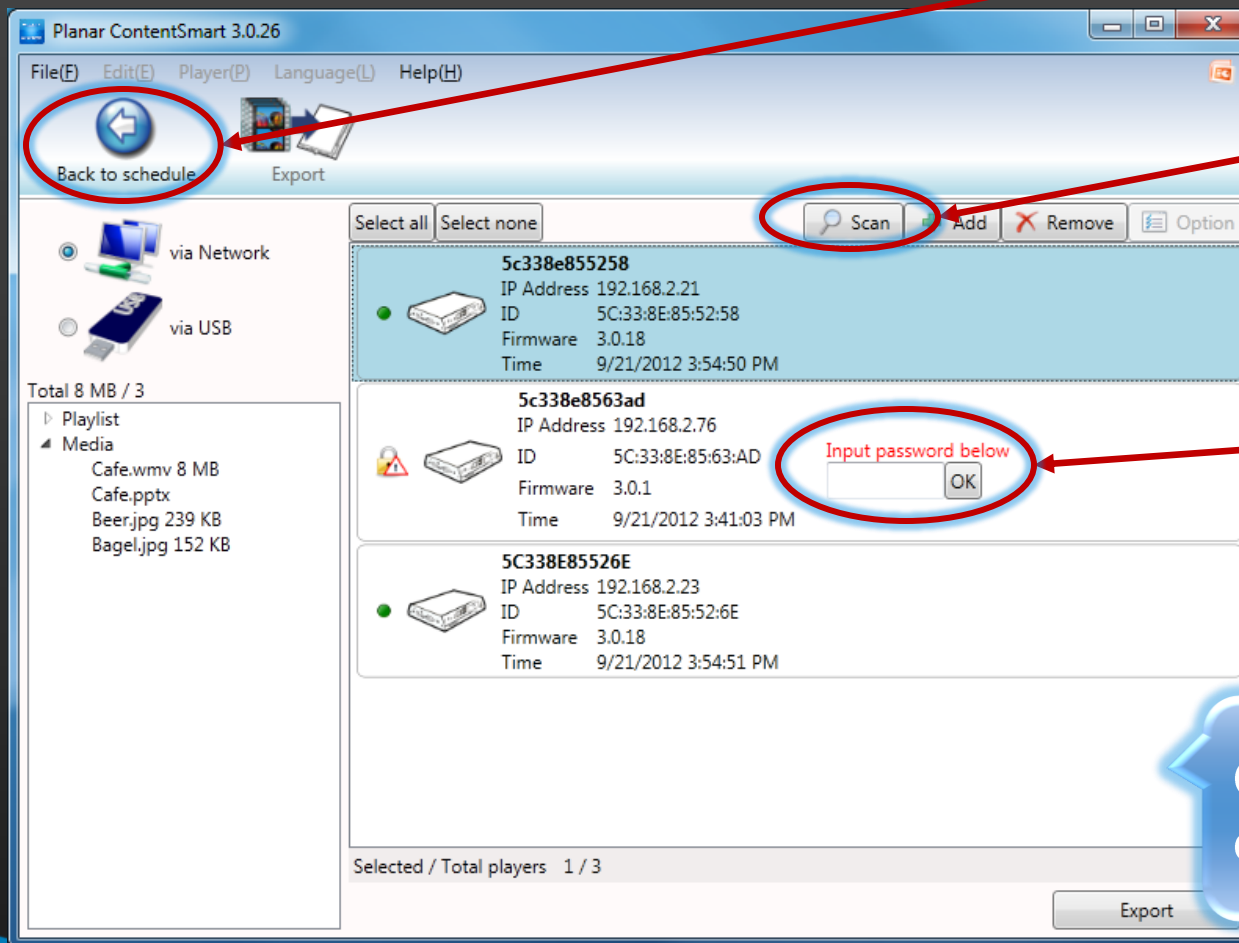

Advanced Settings

- Using PowerPoint with ContentSmart
- Multi-zone scheduling
 - In Looping mode
 - In weekly schedule mode
 - Schedule text ticker
- Aspect ratio
 - Schedule in portrait mode
- Fit to screen setting
 - Fit inside zone (keep aspect ratio)
 - Fit and trim to zone (keep aspect ratio)
 - Fit zone exactly (does not keep aspect ratio)
- Schedule A/V-in
- Schedule GPIO/Buttons layout
- Schedule SmartWidgets
- Multilingual selection
- And more...

Using PowerPoint with ContentSmart

- Add information to your images
 - Adding information to your image by using words, tables and other elements – even in portrait mode!
- Transparent table + background image
 - Creating beautiful & easy-to-modify menu or ads with transparent table and background image.
- Animations – create simple and attractive movie
 - PowerPoint 2010 can save animated slides in video format.



CAFÉ	SM.	LG.	ICE	
Coffee	0.25	2.50	Coffee	2.25
Espresso	1.85		Lattes	3.30
Americano	2.00	2.50	Flavored Latte	3.00
Latte	3.30	3.65	Mint Java Chip	3.75
Flavored Latte	3.65	4.00	Cookies & Cream	3.75
SPECIAL			Caramel latte	3.75
Lakewood latte	3.75	4.15	Atlanta Smoothie	3.85
Mocha Surprise	3.65	4.00	TASTY	
Fireside Latte	3.85	4.25	Croissant	2.50
COFFEE-LESS			Muffin	1.50
Hot Chocolate	2.00	2.50	Coffee Cakes	1.00
Green Chai	3.00	3.50	Bagels	1.50
Hot Tea	2.00		Cream Cheese	.25
			Chips	.60

CAFÉ	SM.	LG.	ICE	
Coffee	1.25	1.50	Coffee	2.25
Espresso	1.85		Lattes	3.30
Americano	2.00	2.50	Flavored Latte	4.00
Latte	3.30	3.65	Mint Java Chip	3.75
Flavored Latte	3.65	4.00	Cookies & Cream	3.75
SPECIAL			Caramel latte	3.75
Lakewood latte	3.75	4.15	Atlanta Smoothie	3.85
Mocha Surprise	3.65	4.00	TASTY	
Fireside Latte	3.85	4.25	Croissant	2.50
COFFEE-LESS			Muffin	1.50
Hot Chocolate	2.00	2.50	Coffee Cakes	1.00
Green Chai	3.00	3.50	Bagels	1.50
Hot Tea	2.00		Cream Cheese	.25
			Chips	.60

Add Information to Your Images



- Change page setup to 16:9
 - Design -> Page Setup -> Slides sized for: -> On-screen Show (16:9)
- Place your images
- Add tables to area you want to add information

Transparent Table + Background Image



CAFÉ	SM.	LG.	ICE	
Coffee	0.25	2.50	Coffee	2.25
Espresso	1.85		Latte5	3.30
Americano	2.00	2.50	Flavored Latte	3.00
Latte	3.30	3.65	Mint Java Chip	3.75
Flavored Latte	3.65	4.00	Cookies & Cream	3.75
			Caramel latte	3.75
			Atlanta Smoothie	3.85
SPECIAL			TASTY	
Lakerwood latte	3.75	4.15	Croissant	2.50
Mocha Surprise	3.65	4.00	Muffin	1.50
Fireside Latte	3.85	4.25	Coffee Cakes	1.00
			Bagels	1.50
COFFEE-LESS			Cream Cheese	.25
Hot Chocolate	2.00	2.50	Chips	.60
Green Chai	3.00	3.50		
Hot Tea	2.00			

- Change page setup to 16:9
 - Design -> Page Setup -> Slides sized for: -> On-screen Show (16:9)
- Change background to image
 - Right click on empty space of slide -> Format Background -> Picture or texture fill -> choose your file and check "Tile picture as texture"
- Add tables to area you want to add information

Animations - Create Simple and Attractive Movie

CAFÉ		SM.	LG.	ICE	
Coffee	1.25	1.50	Coffee	2.25	
Espresso	1.85		Latte	3.30	
Americano	2.00	2.50	Flavored Latte	4.00	
Latte	3.30	3.65	Mint Java Chip	3.75	
Flavored Latte	3.65	4.00	Cookies & Cream	3.75	
SPECIAL					
Lakewood latte	3.75	4.15	Caramel latte	3.75	
Mocha Surprise	3.65	4.00	Atlanta Smoothie	3.85	
Fireside Latte	3.85	4.25	TASTY		
COFFEE-LESS					
Hot Chocolate	2.00	2.50	Croissant	2.50	
Green Chai	3.00	3.50	Muffin	1.50	
Hot Tea	2.00		Coffee Cakes	1.00	
			Bagels	1.50	
			Cream Cheese	.25	
			Chips	.60	



- Change page setup to 16:9
 - Design -> Page Setup -> Slides sized for: -> On-screen Show (16:9)
- Overlay a table on top of image
 - Change table color and set transparent level to 30%
- Using Animations Pane to script your animation
 - Adding fade-in for images or fade-out to new images
- Save as .WMV
 - Planar MP-3450 can natively play video in WMV format

Multi-zone in Looping Schedule

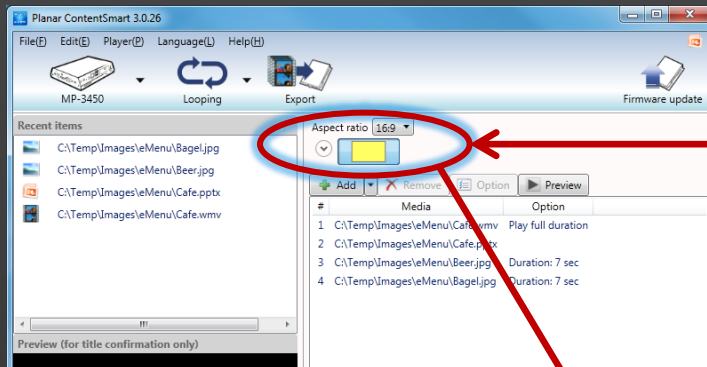

Click on the circle button to expend layout details.

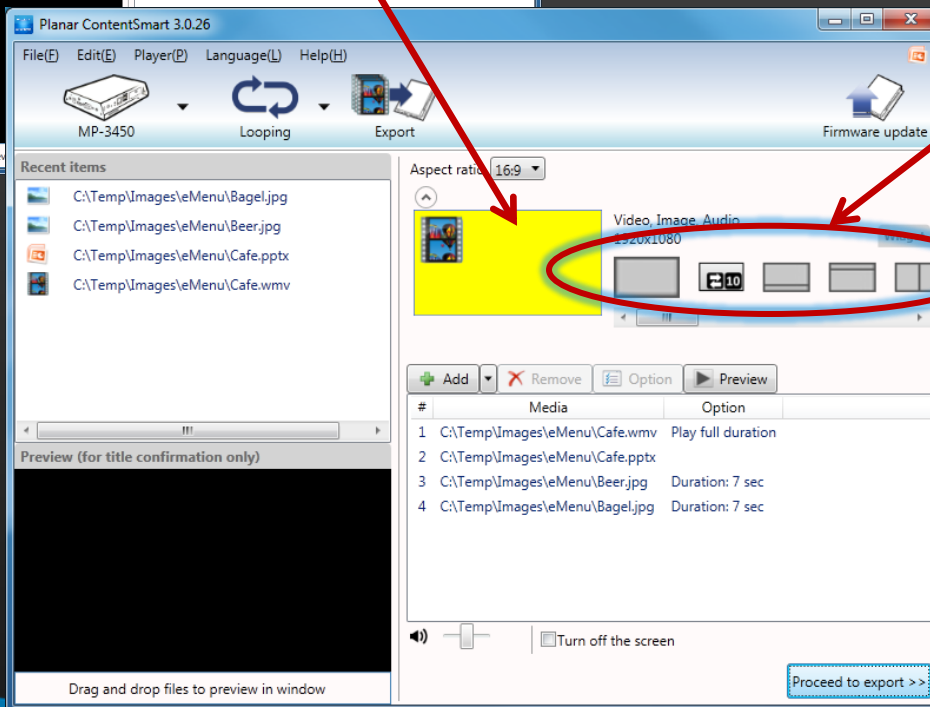

There are many layout templates available to choose from.

Create Looping Playlist for Each Zone

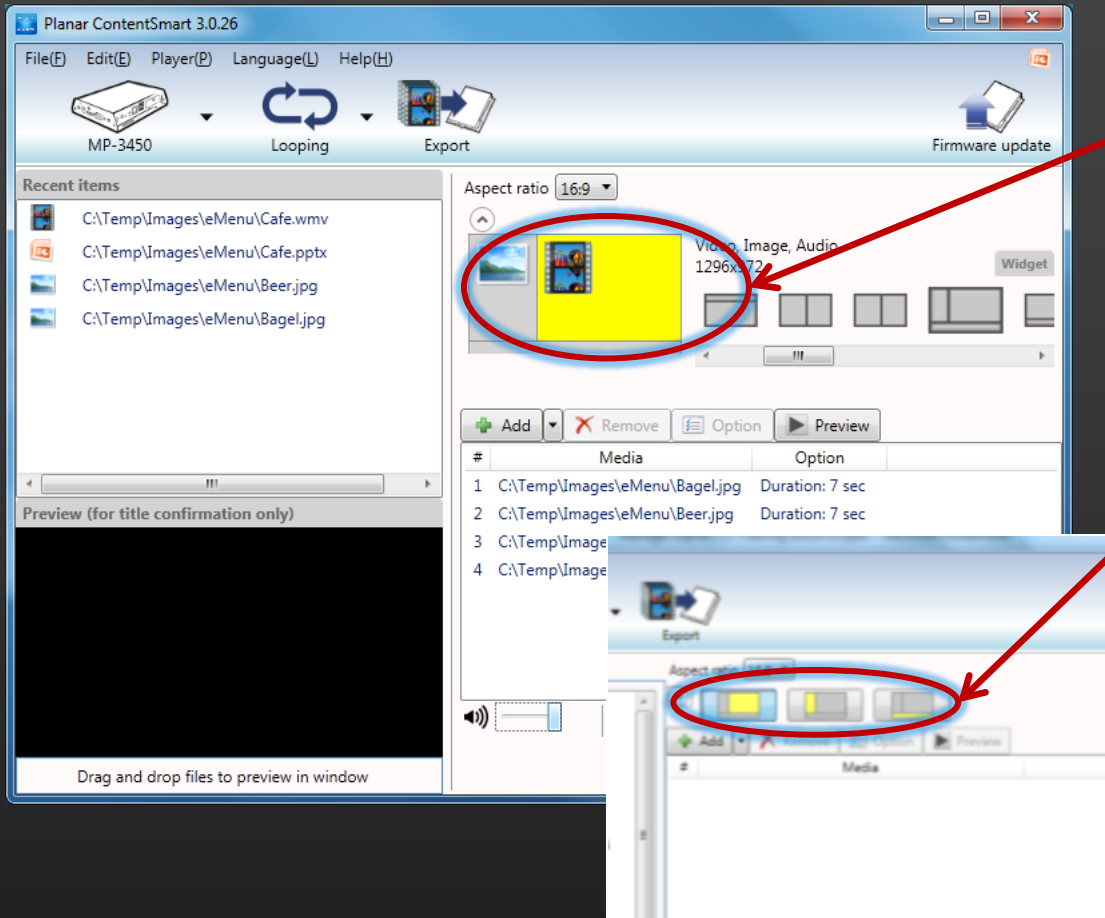

- Click on one of the zones to highlight it in yellow, corresponding playlist for that zone will be shown below.

- You can also select a zone by clicking on the thumbnail.

- Collapse the layout detail if you need more space for playlist.

Create Text Ticker

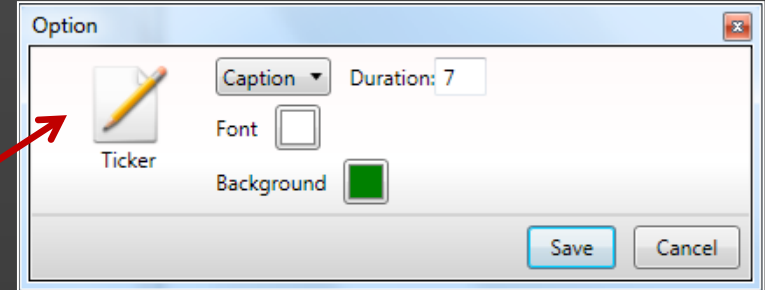
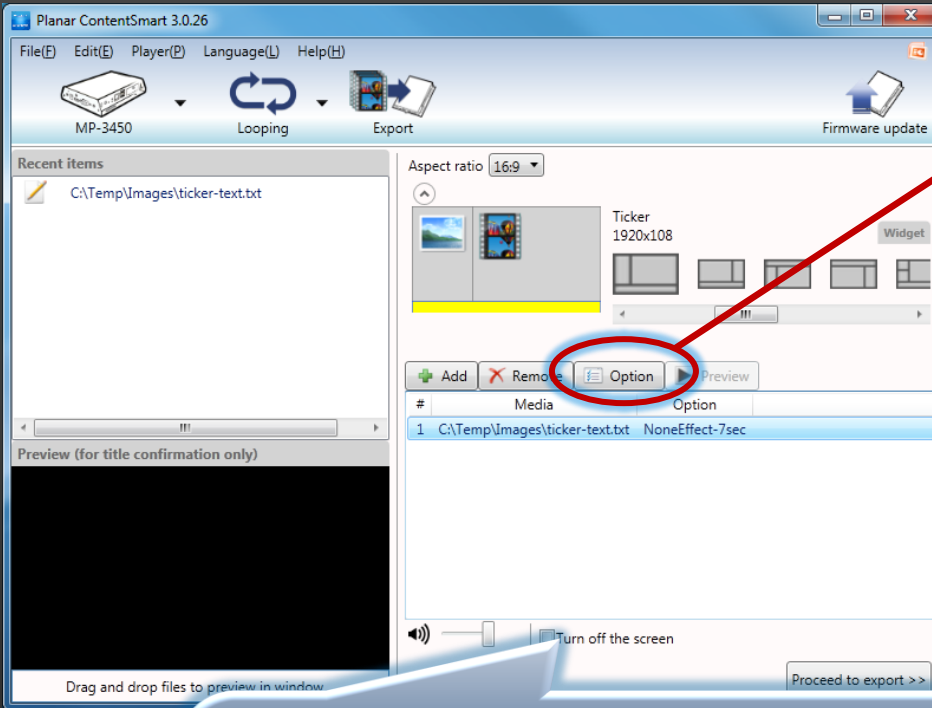

- Create a text file (recommended format: UTF-8).
- Double click on the text file to edit it.
- The text effect and colors can be changed.

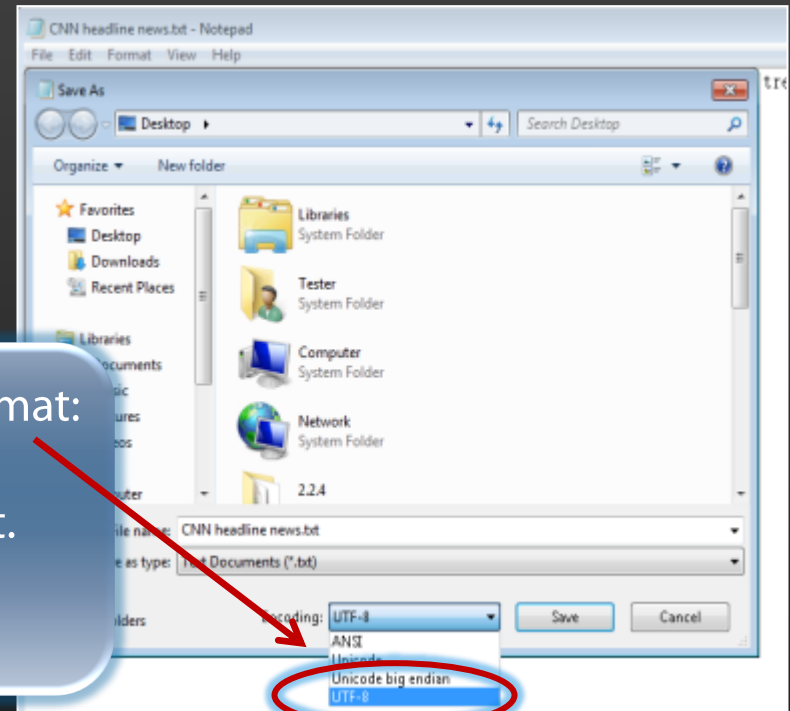

Multi-zone in Weekly Schedule

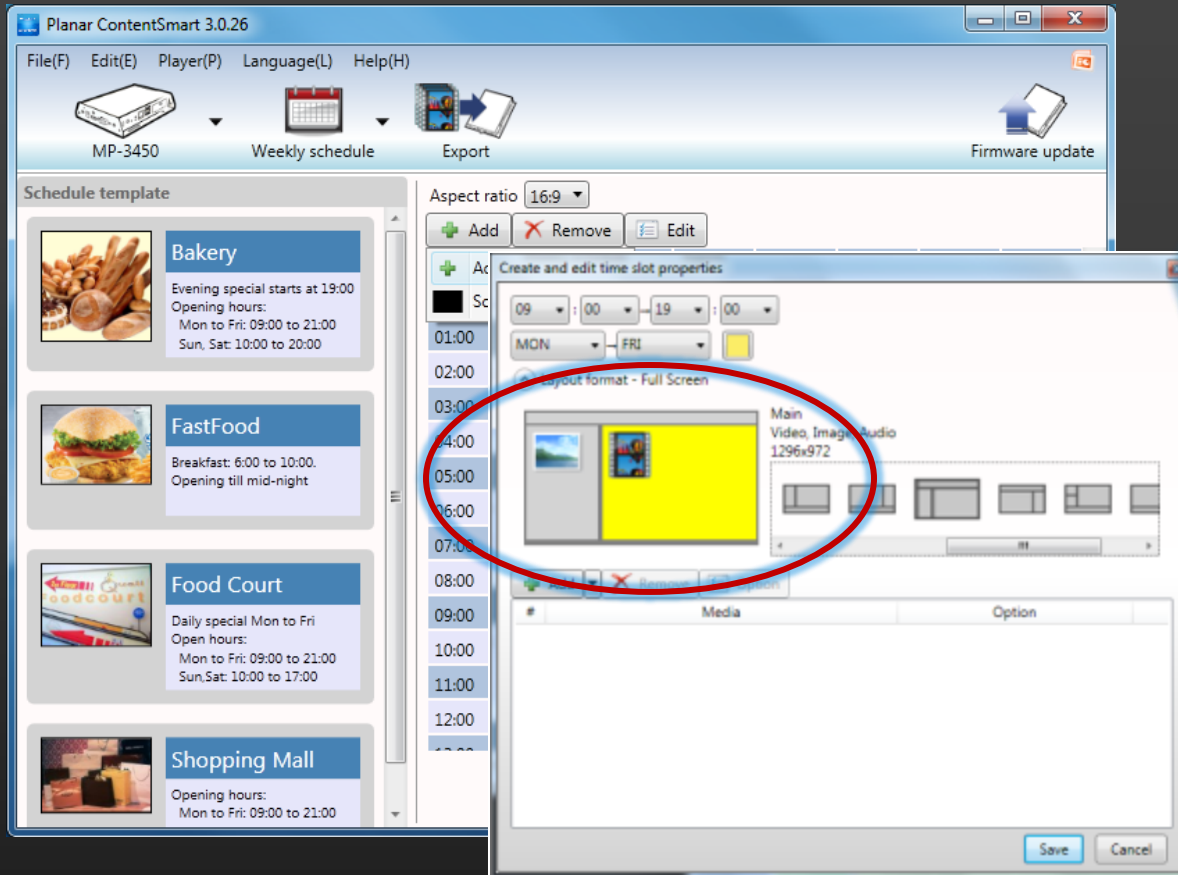

Each time slot can be assigned to a different layout format .

Note there may be a few second blink of black screen if two adjacent time slots are using different layout format.

Layout Aspect Ratio



- Depends on your screen's aspect ratio, you can set different aspect ratio for your player.

- It is recommended to use the same aspect ratio as your screen.

Vertical Aspect Ratio (Portrait Mode)

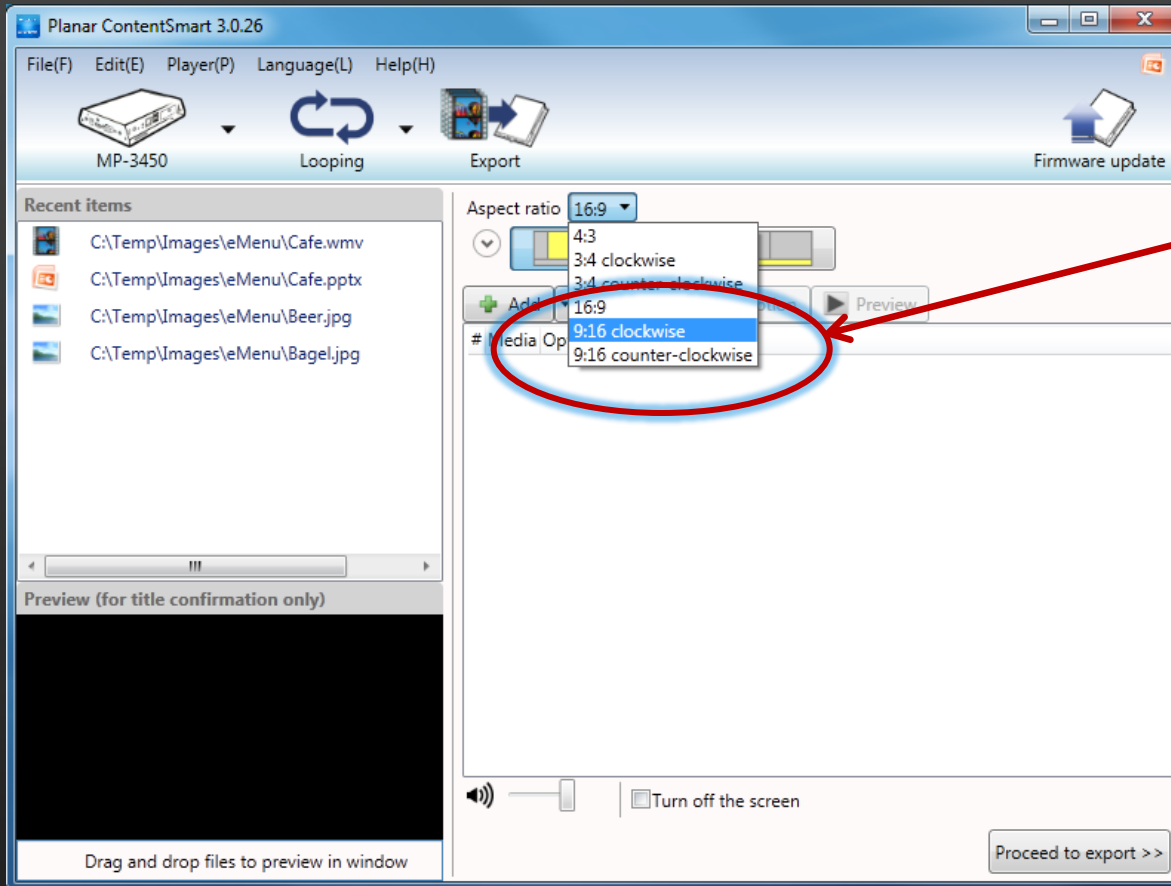

In Aspect ratio, select **clockwise** or **counter-clockwise** layout to schedule media in portrait mode.

Auto Rotate in Portrait Mode

1

Rotate screen.

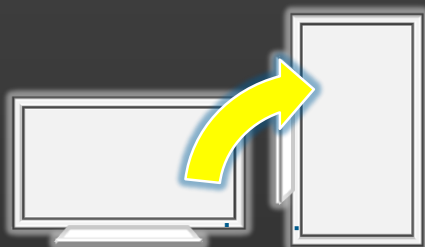

Clockwise

2

Prepare Images or PPT in portrait mode.



Image

3

Choose aspect ratio, schedule file, then export.

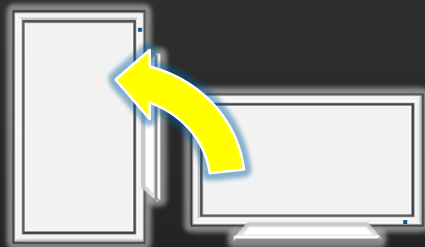
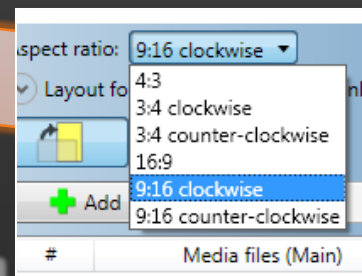

Counter-Clockwise

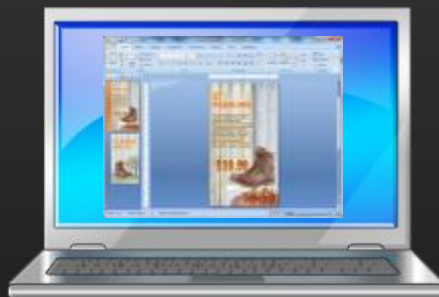

PowerPoint



Rotate Video in Portrait Mode

1

Rotate screen.

2

Prepare portrait video in landscape.

3

Choose aspect ratio, schedule file, then export.

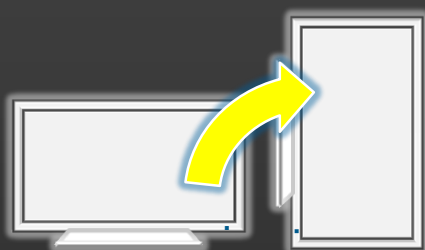

Clockwise

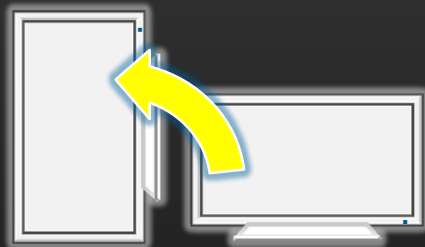

Counter-Clockwise



Convert video from portrait to landscape

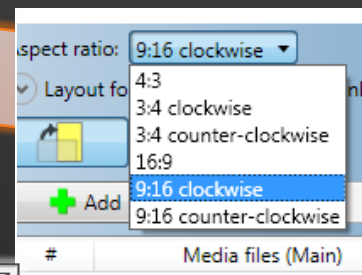

How to Rotate Video

- Using recommended WinMEnc to rotate video
 - Please refer to www.planar.com/support. Follow the instruction on web site, using a free converter.

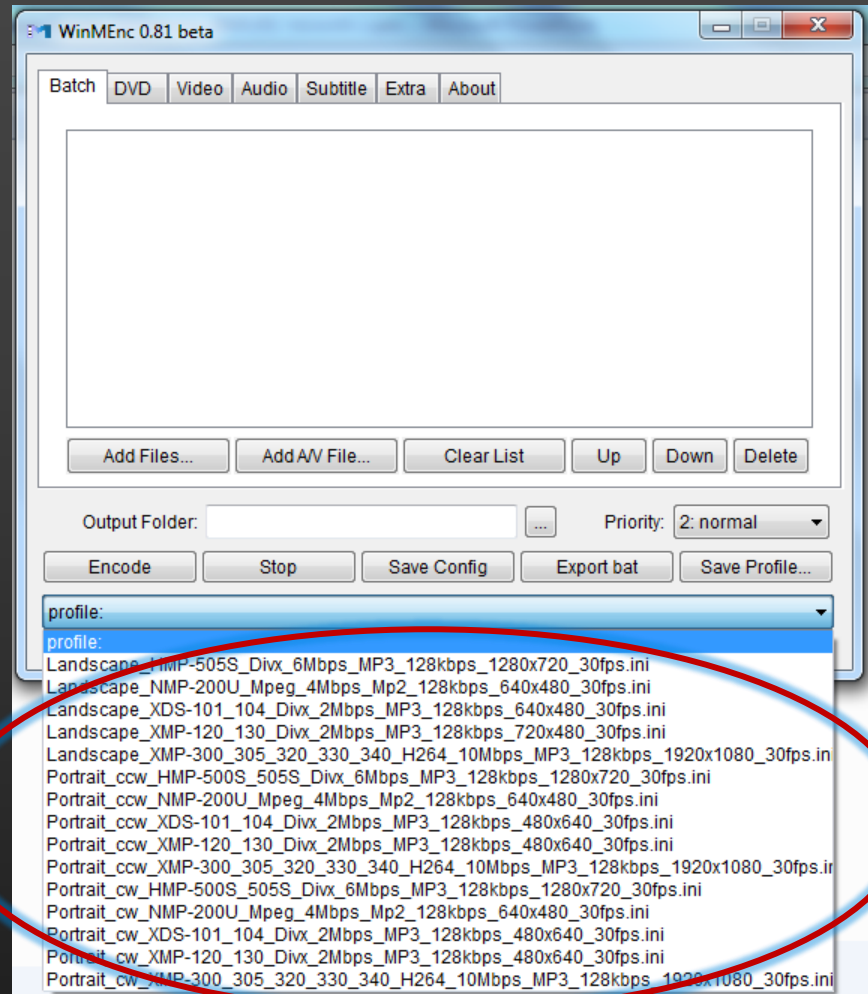

Fit to Screen Options

Select a video on playlist and click on Option.

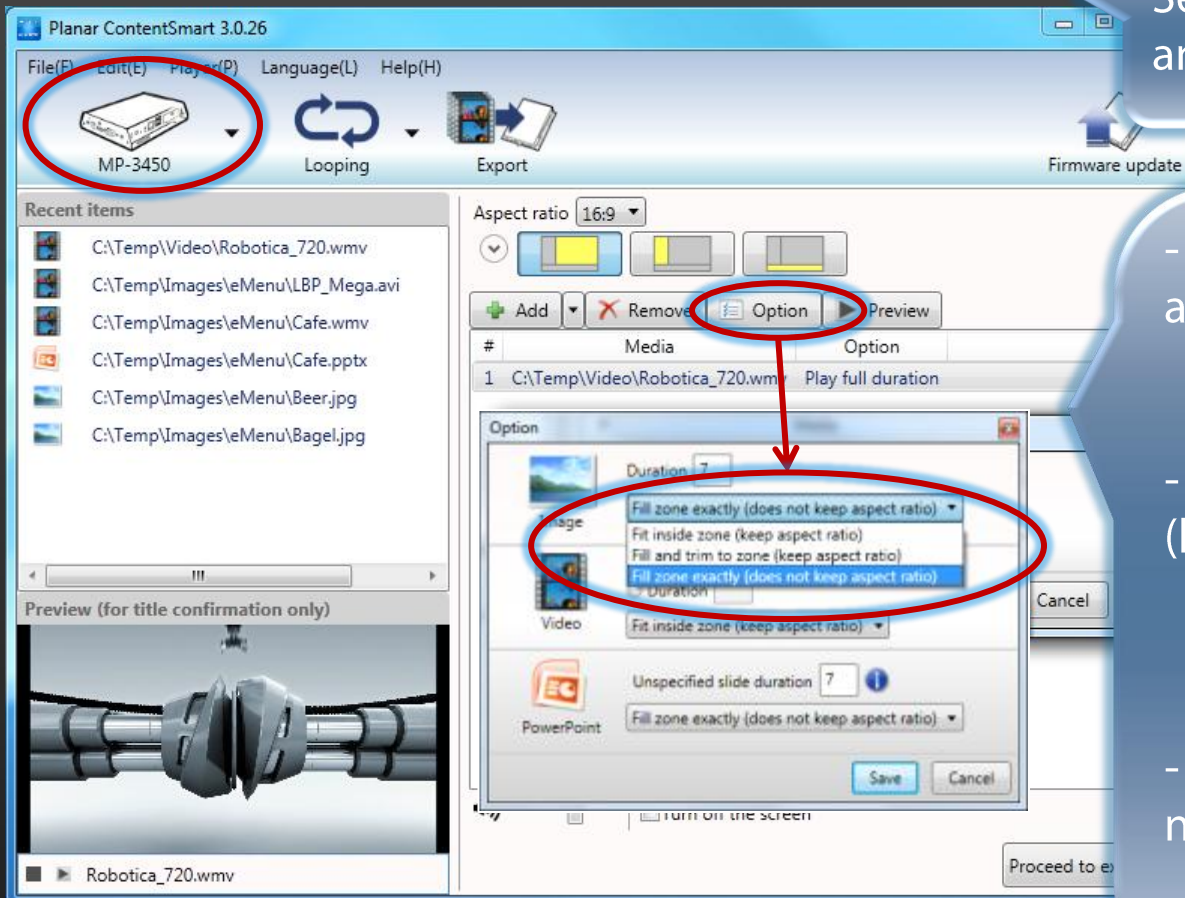

- Fit inside zone (keep aspect ratio)

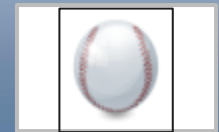

- Fit and trim to zone (keep aspect ratio)



- Fit zone exactly (does not keep aspect ratio)



Schedule A/V-in – Hardware Setup



Live TV news

Slide show

Text ticker



MP-340



HDMI or
VGA cable

AV
cable



External TV tuner



Cable TV

Example shows how to connect MP-3450 with external TV tuner to schedule A/V-in.

Schedule A/V-in – How to

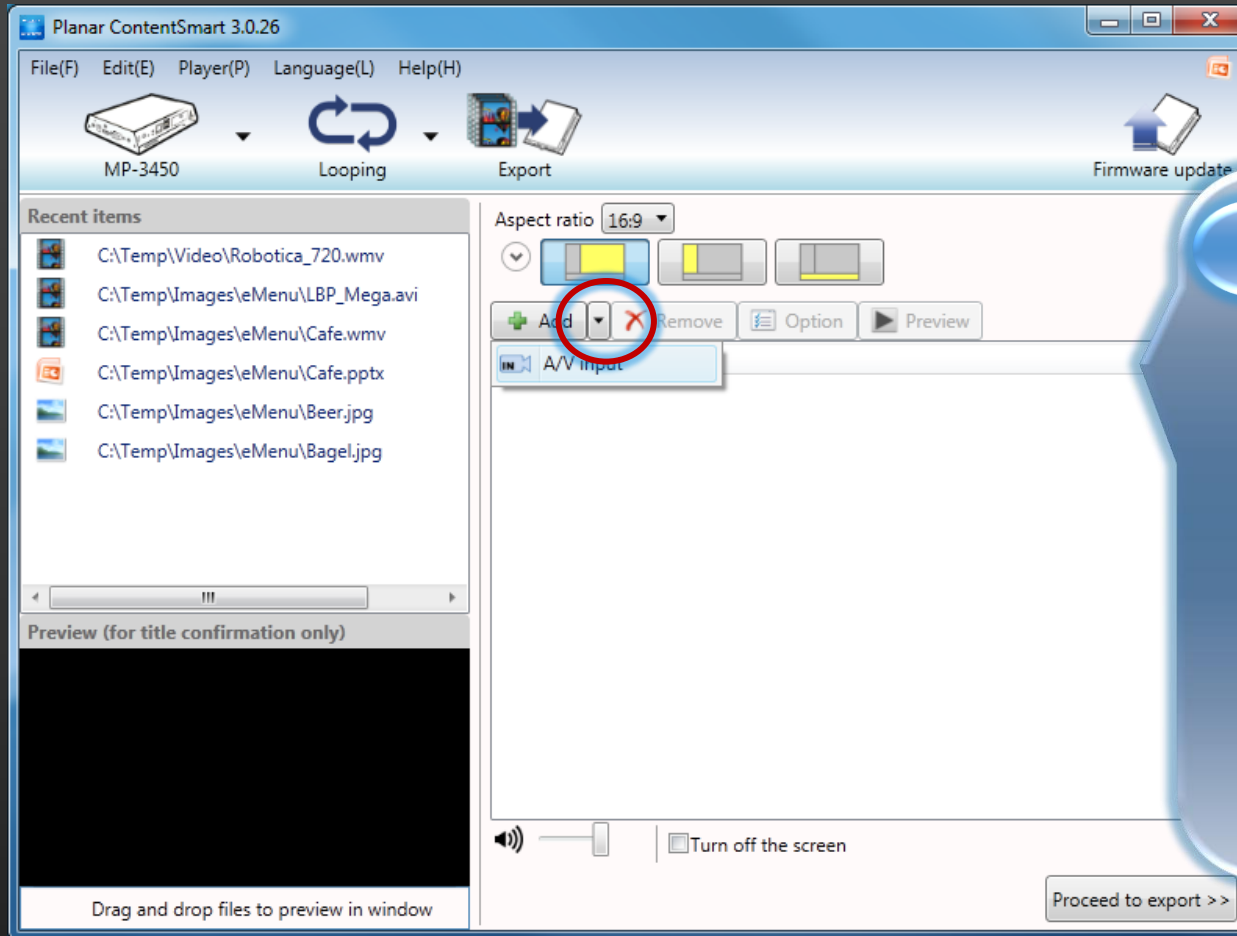

1

Click the **down arrow** button and select “A/V input”.

Schedule A/V-in – How to

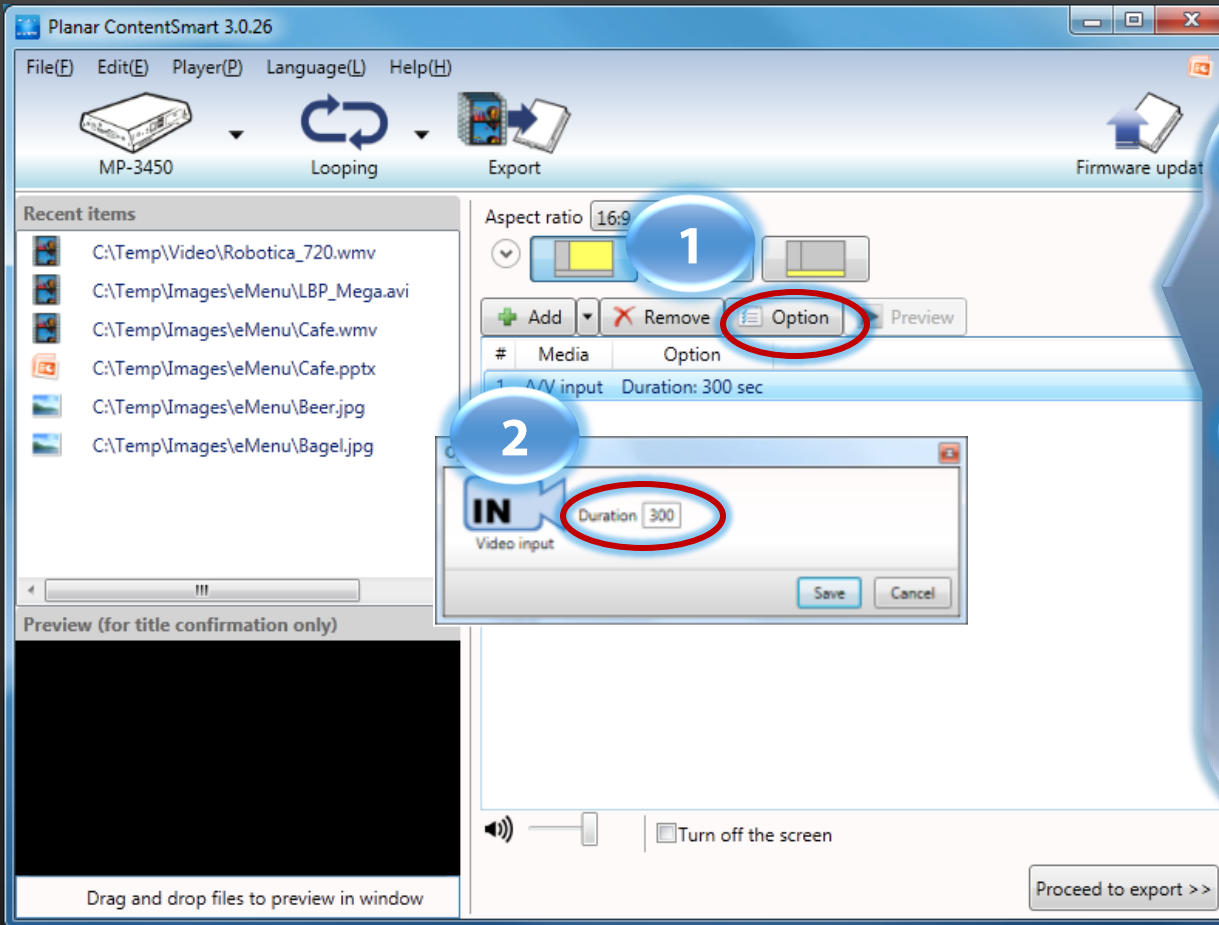

1 Select "A/V input" and click on "Option".

2 The default duration is 300 seconds (5 min). It can be changed to a desired time.

Optional GPIO Adapter PIO-101

- Easy connection to buttons and sensors via USB port.

- For MP-3450
 - Via USB port

- Euro-type terminals
 - Easy to assemble

- 10 inputs, 4 outputs

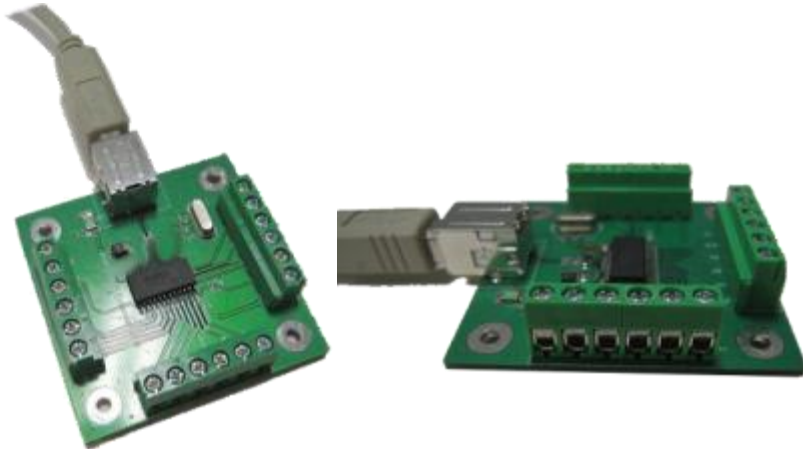

Pump-top Example



Trigger advertisement when someone lifts the gas pump.

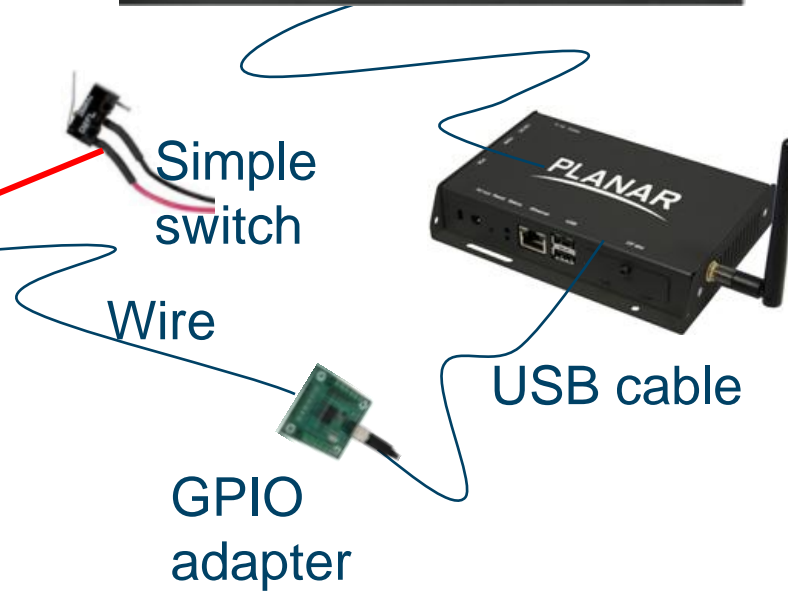

Signage content from server

GPIO – Interactive Museum

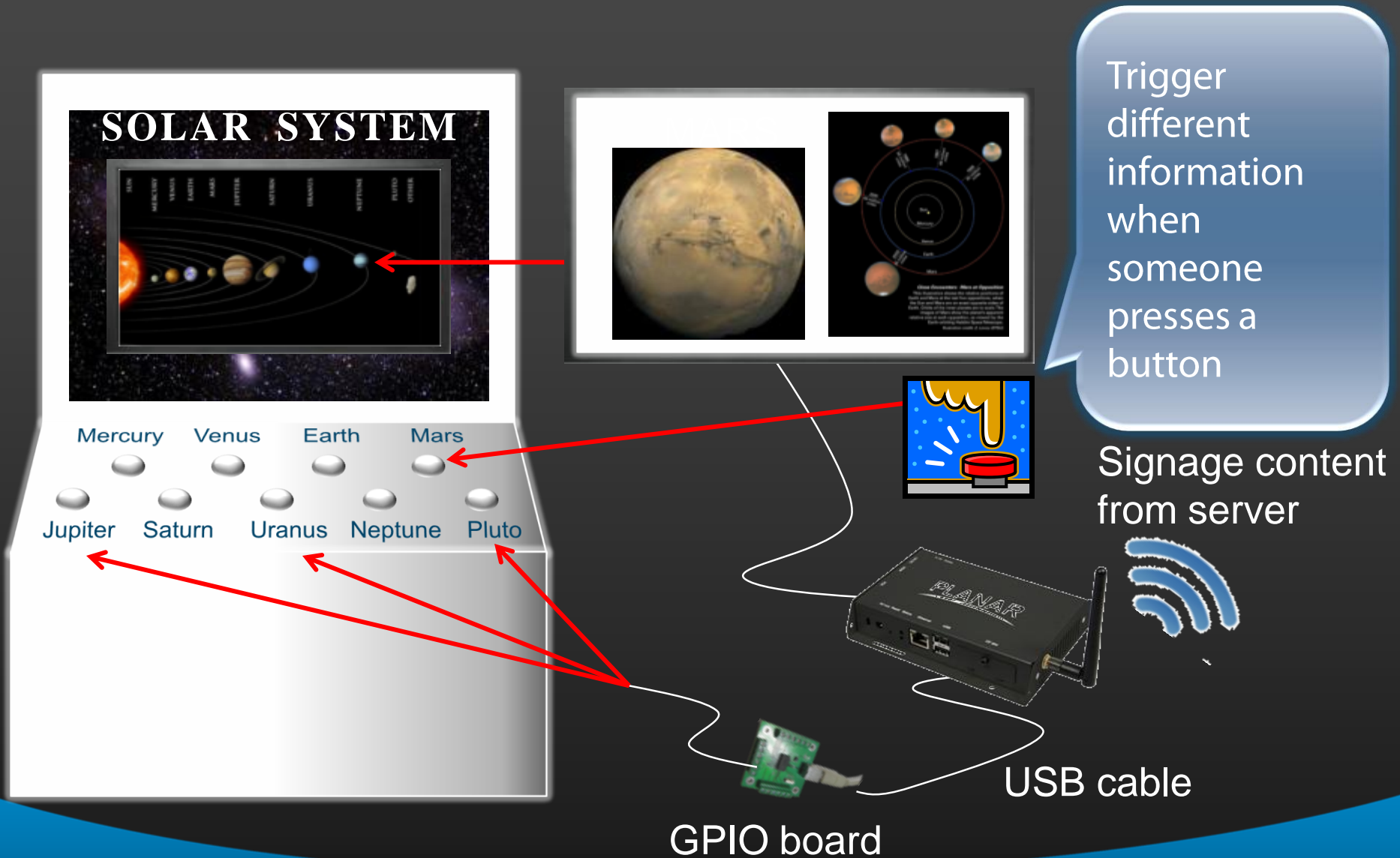

Schedule GPIO

1 Select GPIO template

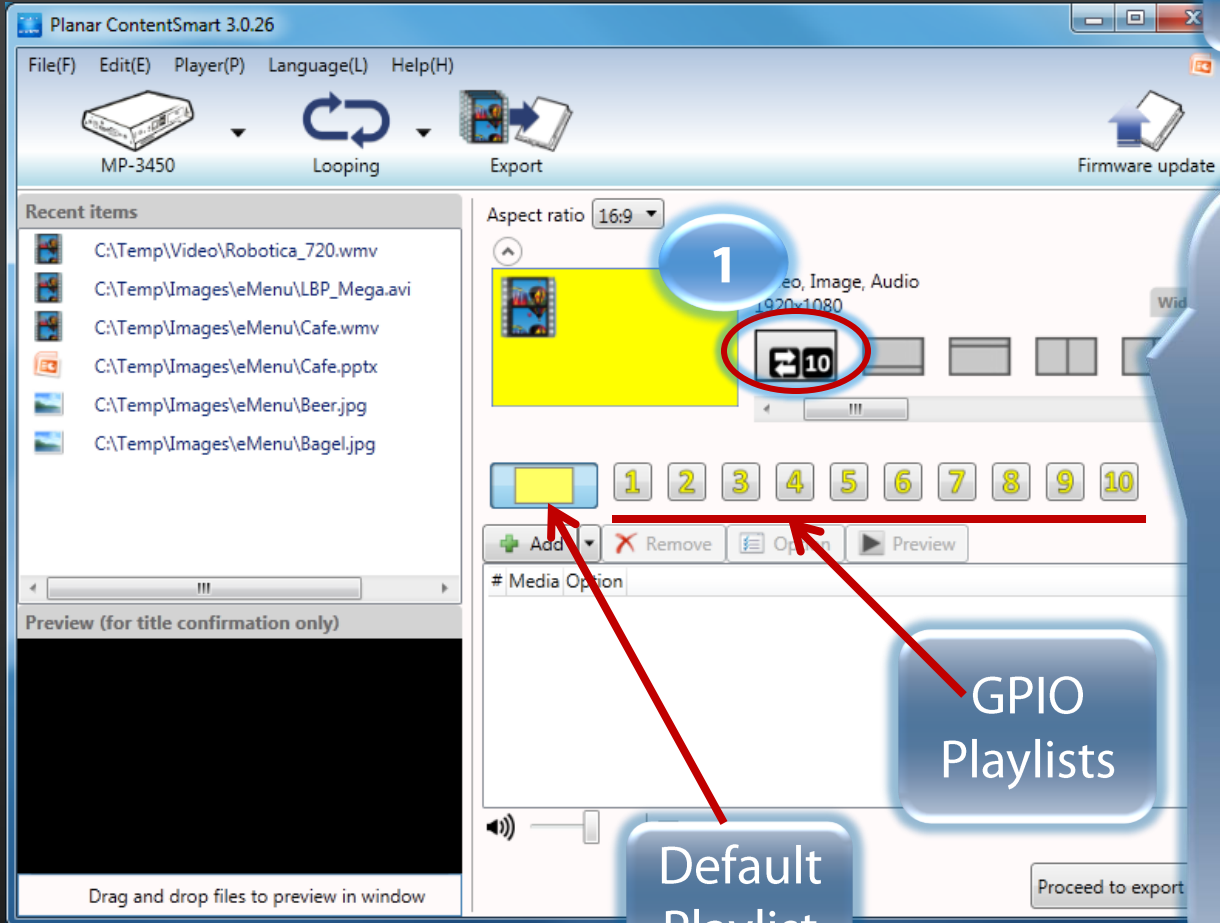

After the end of each GPIO playlist, it will loop back to default playlist.

On digital signboards (XDS-104/151), after triggering a GPIO playlist, other GPIO trigger cannot interrupt playback.

On Full-HD players and signboards, another GPIO trigger can interrupt current playback and starts new playlist immediately.

Default Playlist

GPIO Playlists

Smart Widgets

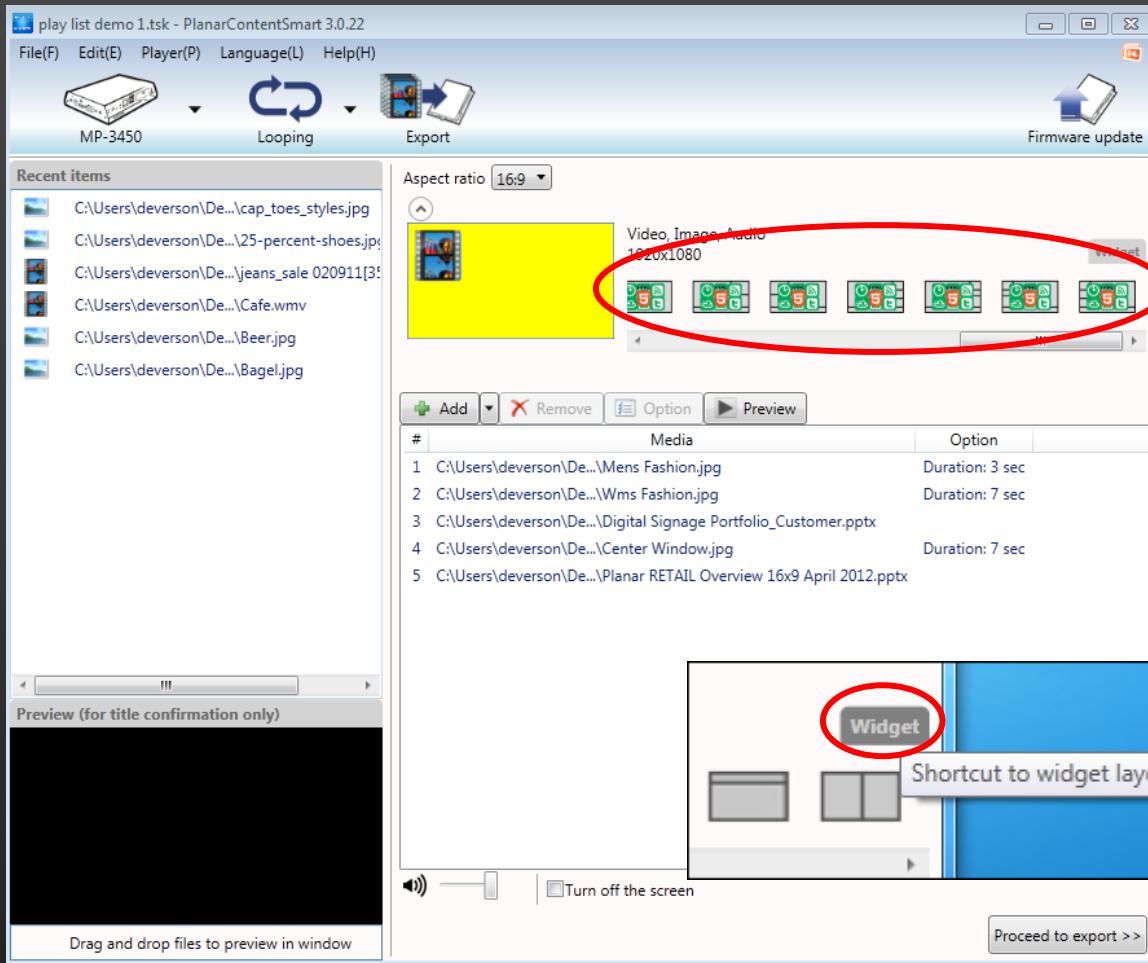

Select one of the Smart Widget templates.



The **Widget** button is a shortcut to quickly bring user to widget layouts.

7 Smart Widgets Templates



7 SmartWidgets layouts:

- 1 x Full screen (1920x1080)
- 4 x layouts with 16:9 main region (1600x960) for wide screen video
- 2 x layouts with 4:3 main region (1296x972) for standard video or AV-input
- Note: Ticker Zone in SmartWidgets layouts only supports Caption mode when a text file is used

Smart Widgets Options



- Change background color for widgets.
- Select different city, enter city name or post/zip code and display temperature in Celsius or Fahrenheit.
- Enter username for Twitter feed.
- Enter URL for RSS or Webpage.

Clock & Calendar Widgets

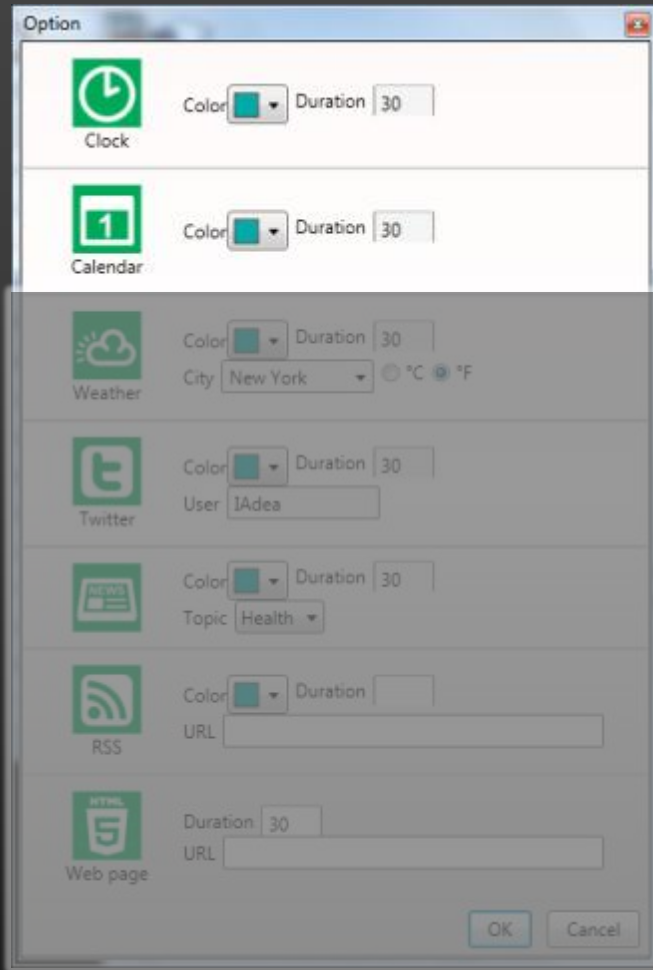

- Under Options, user can modify each Widget's display duration.
- These 2 widgets use player's internal clock to display Clock & Calendar.
- If the time or date is wrong, plug in USB keyboard or connect player to the Internet for time synchronization online.

Weather Widget

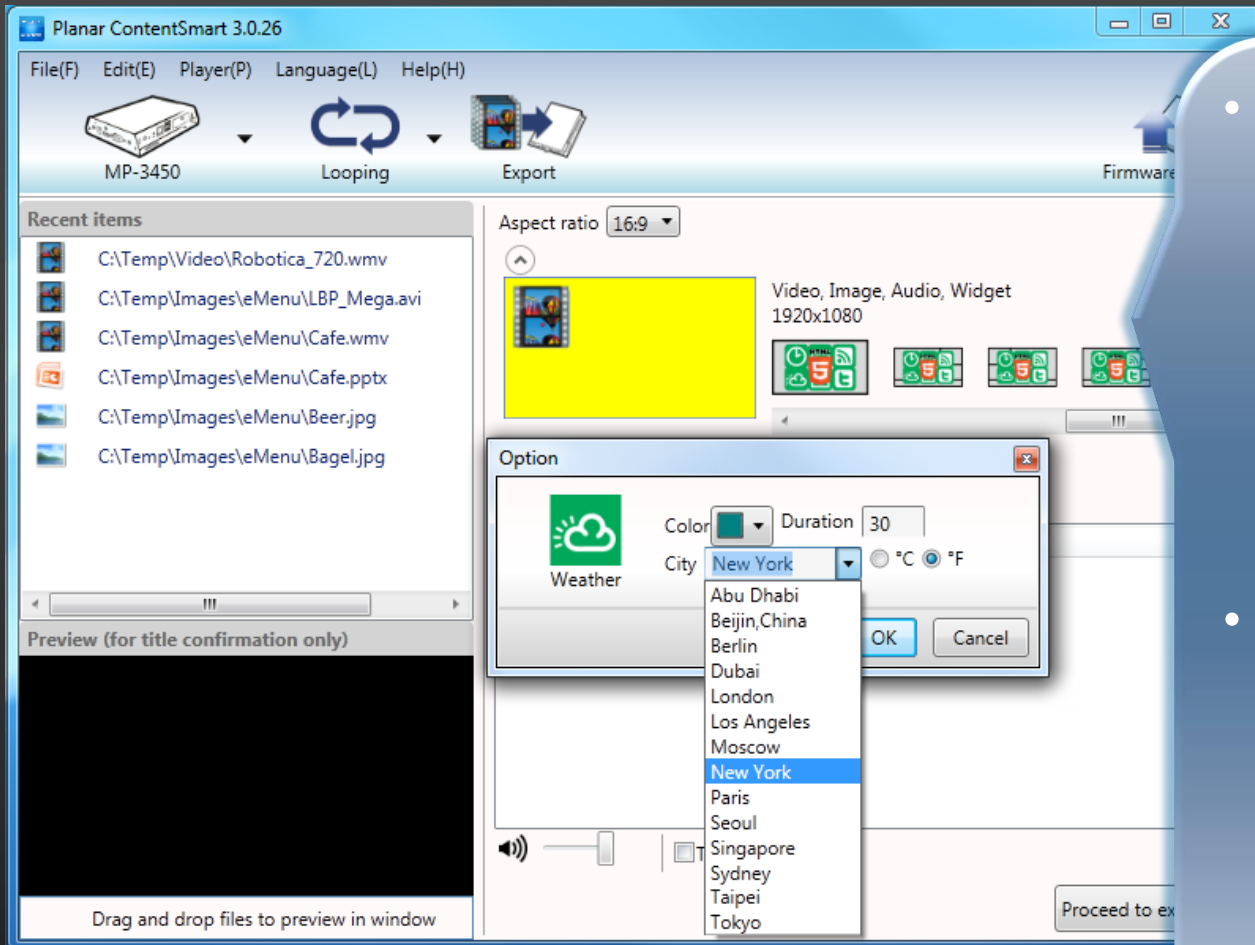

- Weather **Option** will auto pop-up when added to schedule. User must select a city, enter a city name or post/zip code.
- For a list of all supported cities, please visit <http://www.worldweatheronline.com/country.aspx>.

Twitter Widget

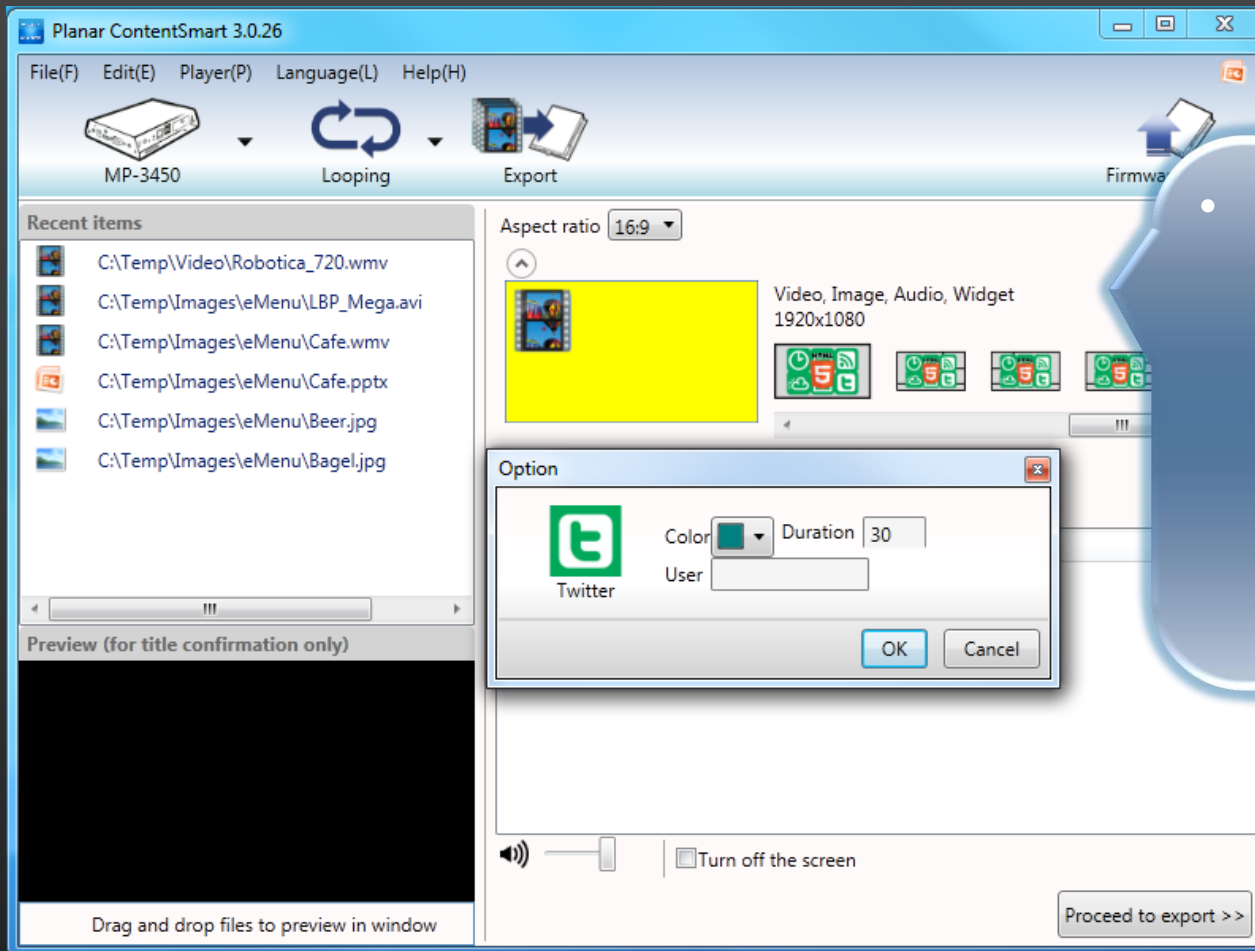

- **Twitter Option** will auto pop-up when added to schedule. A Twitter feed must be entered in the **User** field.

News Widget

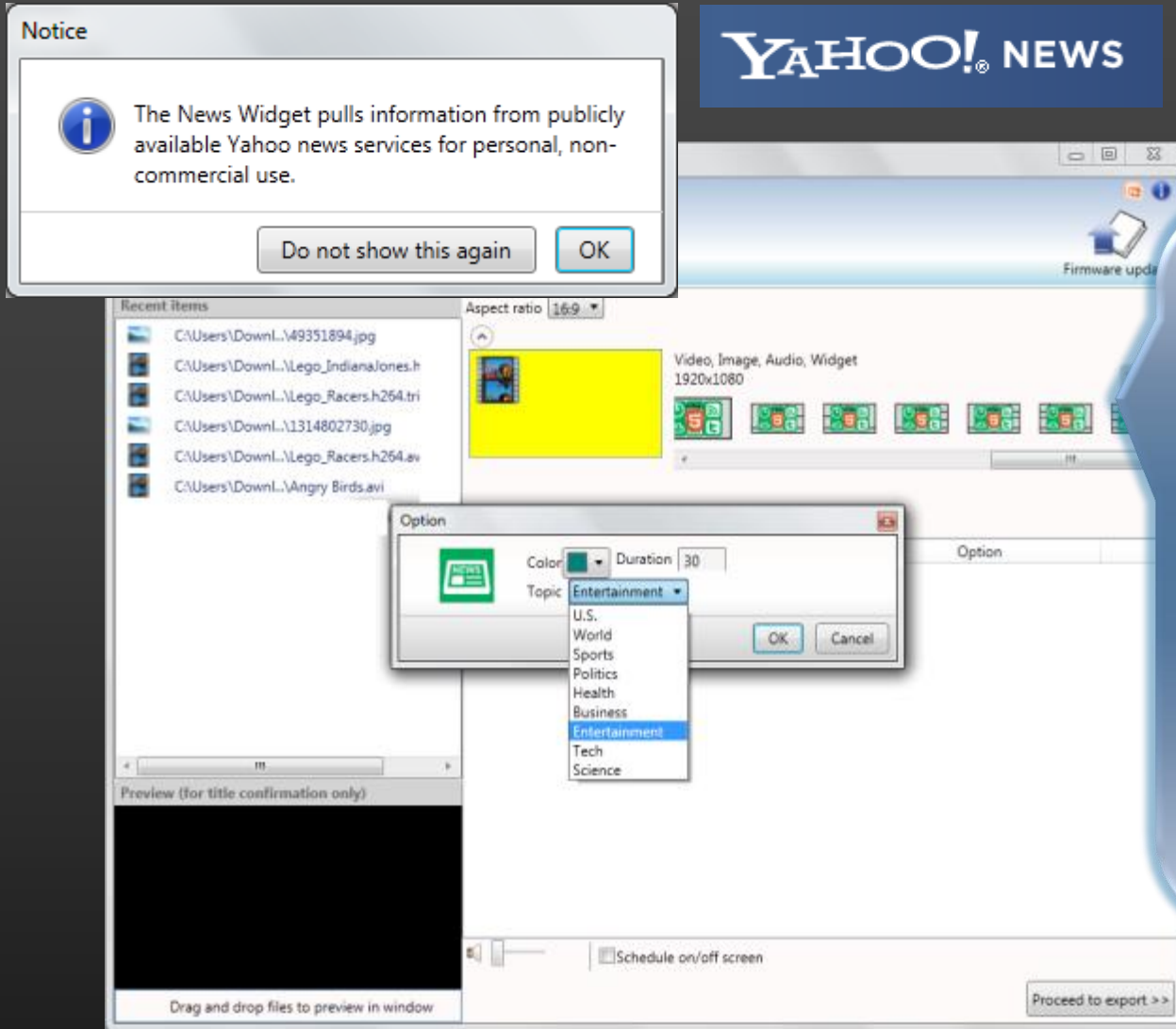

- A warning notice will pop-up when selecting **News** feed. User is responsible for public display of *Yahoo! News*.
- 9 news topics are available for display.

RSS Widget



- **RSS Option** will auto pop-up when added to playlist. User must enter a RSS feed in the URL field.

Web Page Widget



- Web page **Option** will auto pop-up when added to playlist. User must enter a URL.

Multilingual Selection

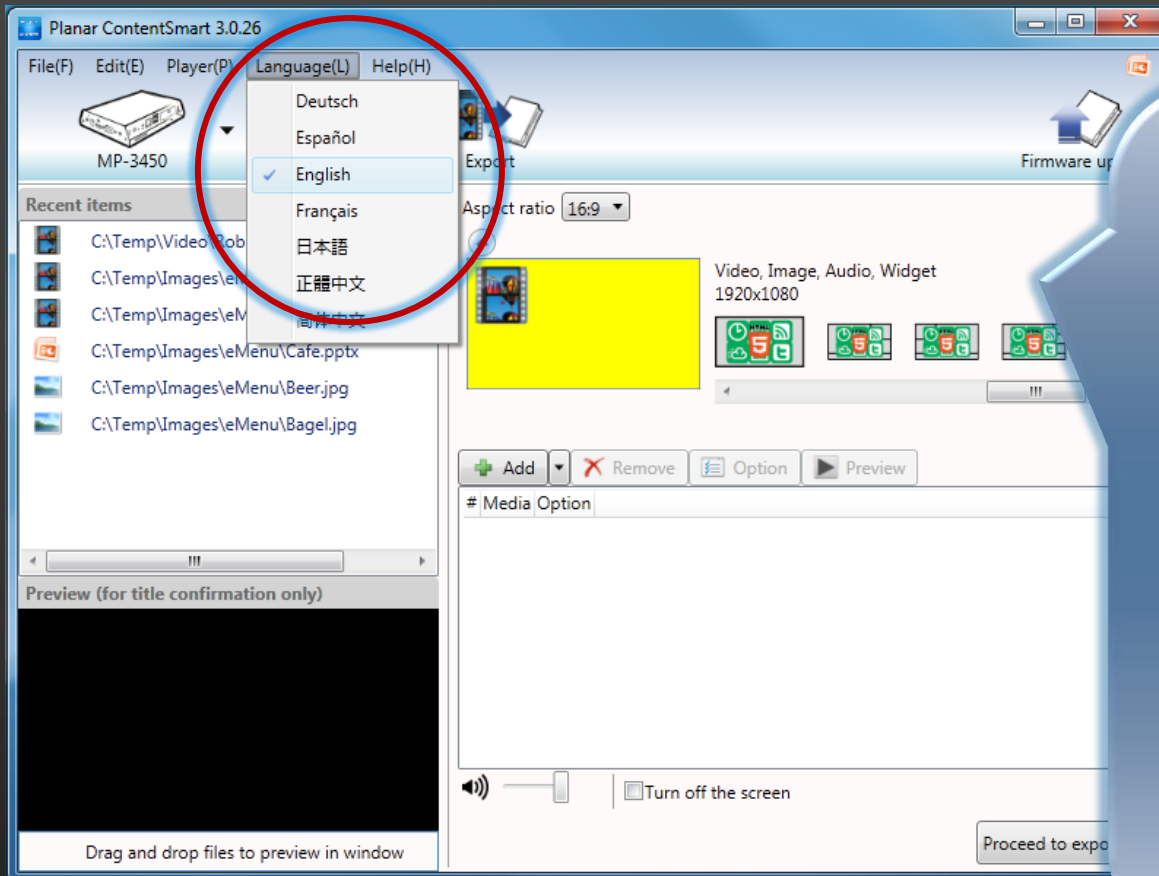

Language options:

- Deutsch (German)
- Espanol (Spanish)
- English
- Français (French)
- 日本語 (Japanese)
- 正體中文 (Traditional Chinese)
- 簡體中文 (Simplified Chinese)

When switching language, program will prompt to restart.

Check the Exporting Log

The screenshot shows the Planar ContentSmart 3.0.26 application window. The interface includes a menu bar (File, Edit, Player, Language, Help), a toolbar with 'Back to schedule' and 'Export' buttons, and a main content area. On the left, there are options for 'via Network' and 'via USB', and a 'Total 24 MB / 3' indicator. Below this is a 'Playlist' section with a 'Media' folder containing files: Robotica_720.wmv (15 MB), Cafe.wmv (8 MB), Cafe.pptx, and Beer.jpg (239 KB). The main content area displays a list of items with columns for 'Select all', 'Select none', 'Scan', 'Add', 'Remove', and 'Option'. Two items are listed:

Select all	Select none	Item	Option
<input type="checkbox"/>	<input type="checkbox"/>	5C338E85526E IP Address 192.168.2.23 ID 5C:33:8E:85:52:6E Firmware 3.0.18 Time 9/25/2012 1:47:54 PM	
<input checked="" type="checkbox"/>	<input checked="" type="checkbox"/>	5c338e85532c IP Address 192.168.2.80 ID 5C:33:8E:85:53:2C Firmware 3.0.18 Time 9/25/2012 1:47:55 PM	Completed. Log

The 'Log' button for the second item is circled in red. A red arrow points from a callout box to this button.

Click on log button to bring up export log window.

The screenshot shows the export log window for item 5c338e85532c. The window title is '5c338e85532c'. The log content is as follows:

```
5c338e85532c
MP-3450(3.0.18)
192.168.2.80(5C:33:8E:85:53:2C)
=====
13:46:12 Export 4/10
13:46:12 Upload: /media/Robotica_720.wmv C:\Temp\Video\Robotica_720.wmv
13:46:19 Export 5/10
13:46:19 Upload: /media/Cafe.wmv C:\Temp\Images\eMenu\Cafe.wmv
13:46:23 Export 6/10
13:46:23 Upload: /media/Beer.jpg C:\Temp\Images\eMenu\Beer.jpg
13:46:23 Export 7/10
13:46:23 Upload: /index.smil C:\Users\Jason\AppData\Local\Planar ContentSmart\Tmp\41-
13:46:23 Export 8/10
```

An 'OK' button is located at the bottom right of the window.

Export to the USB Drive

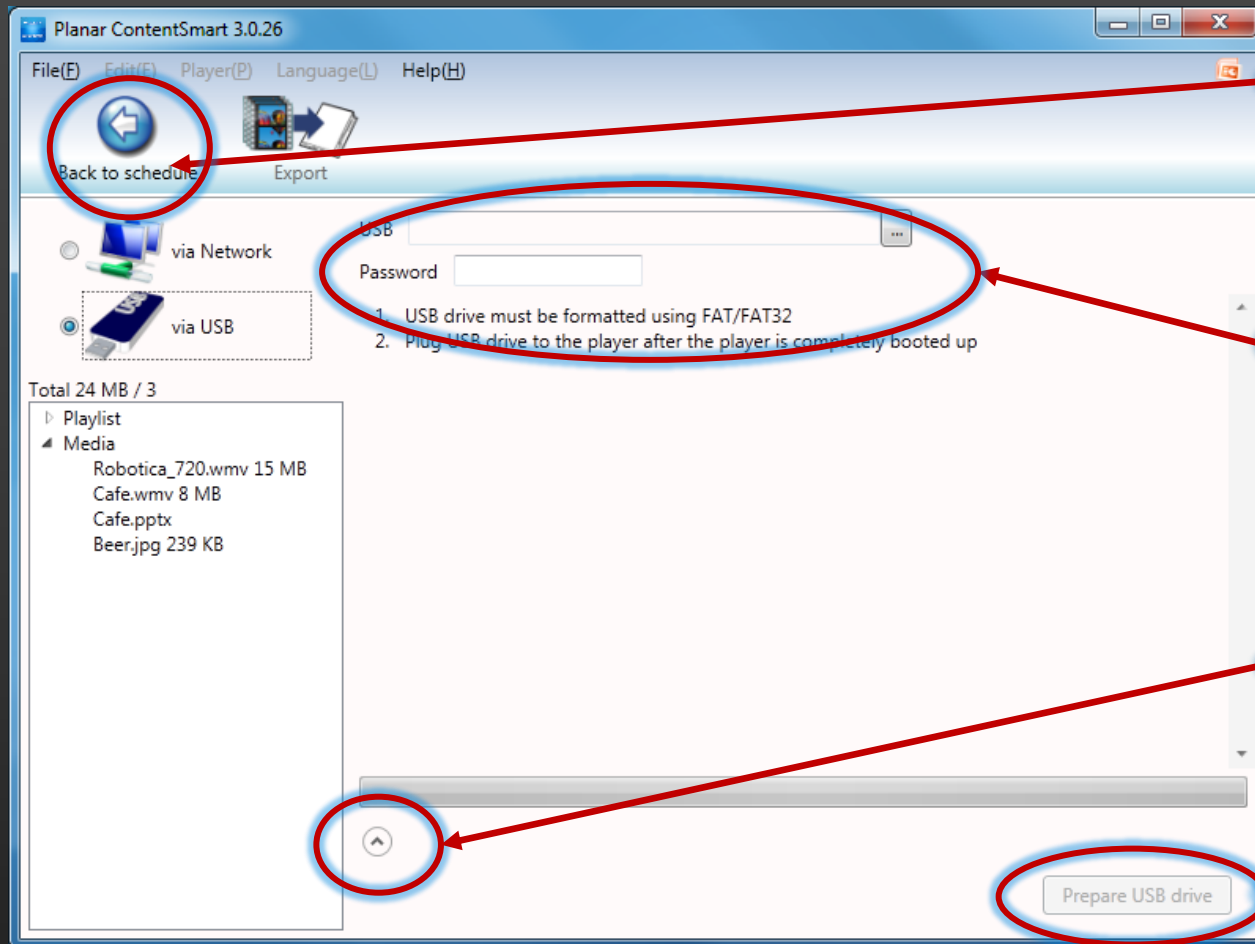

Back to previous steps

- Select your target drive.
- Enter password if player is password protected.

Click to expand exporting log .

Click **Prepare USB drive** to export content.

Save your Playlist

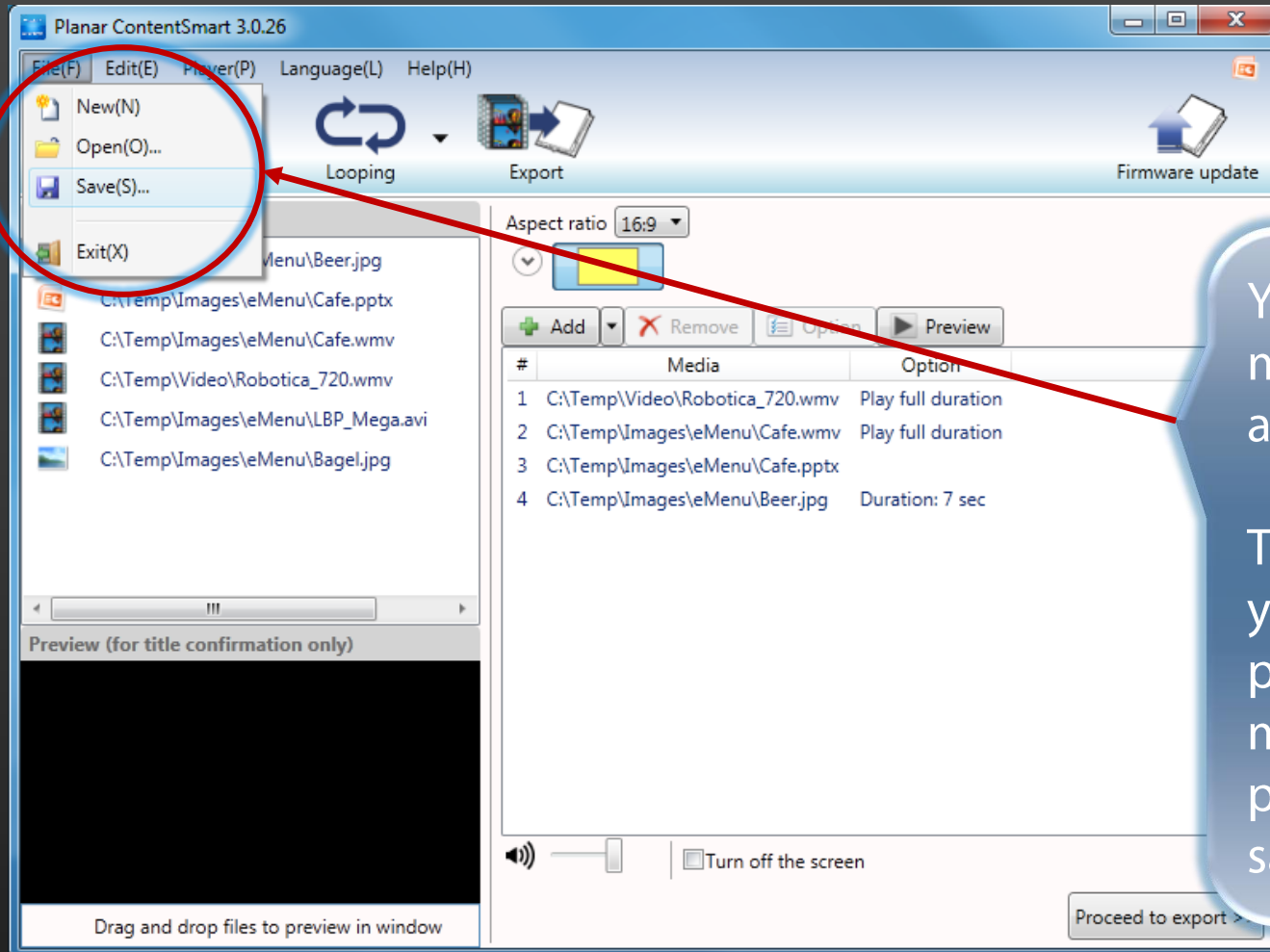

Your playlist may be saved as a task file (.tsk)

The next time you use this program, you may open a previously saved task file.

Develop Playlist and Export

Firmware Update

Firmware Update

Planar ContentSmart 3.0.26

File(E) Edit(E) Player(P) Language(L) Help(H)

MP-3450 Looping Export

Recent items

Aspect ratio 16:9

Planar ContentSmart 3.0.26

File(E) Edit(E) Player(P) Language(L) Help(H)

Back to schedule Firmware update

Select all Select none Scan Add Remove Option

MP-3450

via Network

via USB

Firmware

Please select firmware.

5C338E85526E
IP Address 192.168.2.23
ID 5C:33:8E:85:52:6E
Firmware 3.0.18
Time 9/25/2012 2:14:48 PM
5c338e85532c
IP Address 192.168.2.80
ID 5C:33:8E:85:53:2C
Firmware 3.0.18
Time 9/25/2012 2:14:48 PM

Log

Selected / Total players 1 / 2

Firmware update

Click **Firmware update** to go to firmware upgrading page.

Two firmware upgrade methods:

- via Network
- via USB

Locate your Firmware

" data-bbox="57 121 741 811"/>

Planar ContentSmart 3.0.26

File(F) Edit(E) Player(P) Language(L) Help(H)

Back to schedule Firmware update



MP-3450

via Network

via USB

Firmware

Please select firmware. ...

Select all	Select none	
<input type="checkbox"/>	<input type="checkbox"/>	
		5C338E85526E
		IP Address 192.168.2.23
		ID 5C:33:8E:85:52:6E
		Firmware 3.0.18
		Time 9/25/2012 2:26:40 PM
		
		5c338e85532c
		IP Address 192.168.2.80
		ID 5C:33:8E:85:53:2C
		Firmware 3.0.18
		Time 9/25/2012 2:26:41 PM
		<input type="button" value="Log"/>

Selected / Total players 1 / 2

Click on "... " button and locate the firmware package.

You can download the latest firmware online or locate it on the bundled CD.

Upgrade Player Firmware via Network

Planar ContentSmart 3.0.26

File(F) Edit(E) Player(P) Language(L) Help(H)

Back to schedule Firmware update

MP-3450

via Network

via USB

Firmware

C:\Temp\Firmware\XMP-320,3...

Select all Select none Scan Add Remove Option

5C338E85526E	IP Address 192.168.2.23	ID 5C:33:8E:85:52:6E	Firmware 3.0.18	Time 9/25/2012 2:43:15 PM
5c338e85532c	IP Address 192.168.2.80	ID 5C:33:8E:85:53:2C	Firmware 3.0.18	Time 9/25/2012 2:43:16 PM

Processing

Upgrade 6/9 Log

Selected / Total players 1 / 2 Executing: 1

Firmware update

Select player model

Select firmware

Choose player by clicking on it and highlight it in blue

Click on **Firmware update** to start the upgrading process

Firmware Update Instructions via USB

The screenshot shows the Planar ContentSmart 3.0.26 software window. The title bar reads "Planar ContentSmart 3.0.26". The menu bar includes "File(F)", "Edit(E)", "Player(P)", "Language(L)", and "Help(H)". Below the menu bar are two buttons: "Back to schedule" and "Firmware update". The main interface has a left sidebar with "MP-3450" selected, and options for "via Network" and "via USB". A "Firmware" section shows a file path: "C:\Temp\Firmware\XMP-320,3...". The central area contains a diagram of a computer connected to a media player via a USB drive, with numbered steps 1 and 2. Step 1 shows a USB drive being prepared. Step 2 shows the USB drive being inserted into the media player. A "Upgrade Complete" message is shown on the media player screen. To the right of the diagram, there are three steps of instructions: Step 1: Prepare your USB using Planar ContentSmart. Not USB drive must be formatted using FAT or FAT32. It is recommended that you do not store other files on the USB drive. Step 2: Turn on your display, plug in a USB keyboard and power on the media player. Wait until the player boots up into the menu, then go to firmware update menu. The player will prompt you to insert the USB drive to initiate update. A progress bar lets you know the status. IMPORTANT: Once initiated, DO NOT disconnect USB or Power! Step 3: When "Update Complete" is shown on screen, the player will auto-restart and resume playback. Unplug the USB drive. At the bottom right, there is a button labeled "Prepare USB drive".

Firmware upgrade instructions via USB are described in detail.

Prepare the USB drive, then follow instructions to upgrade player.

Firmware Update Instructions via USB

Planar ContentSmart 3.0.26

File(F) Edit(E) Player(P) Language(L) Help(H)

Back to schedule Firmware update

MP-3450

via Network

via USB

USB F:\

Password

3:04:25 PM Folder deleted : [F:\SMIL]
3:04:25 PM File deletion complete.
3:04:33 PM Copied from [C:\Temp\Firmware\XMP-320,330,340,3250,3350,3450\SMF864X-ADAPI-INS]
3:04:33 PM Files copied.

Firmware
C:\Temp\Firmware\XMP-320,3...

Files copied.

You can check the exporting process by clicking on the circular button

THANK YOU



Please consider the environment before printing this presentation